

**LANGER**  
EMV-Technik

# IC TEST SYSTEM

User Manual

**P501 / P503 set**

RF Power Injection



<b>Table of Contents</b>	<b>Page</b>
<b>1 Declaration of Conformity .....</b>	<b>3</b>
<b>2 General Information .....</b>	<b>4</b>
2.1 Storage of the User Manual .....	4
2.2 Reading and Understanding the User Manual .....	4
2.3 Local Safety and Accident Prevention Regulations .....	4
2.4 Images .....	4
2.5 Limitation of Liability .....	4
2.6 Errors and Omissions .....	4
2.7 Copyright .....	4
<b>3 Safety .....</b>	<b>5</b>
3.1 Labels and Signs .....	5
3.2 Intended Use.....	5
3.3 Reasonably foreseeable Misuse .....	5
3.4 Staff Requisition.....	6
3.5 Safety Instructions .....	6
<b>4 Scope of delivery.....</b>	<b>7</b>
<b>5 P500 Probe Set .....</b>	<b>8</b>
5.1 General Description .....	8
5.2 Design and Function .....	9
<b>6 Operational Notes.....</b>	<b>10</b>
<b>7 Measurement Set-Up.....</b>	<b>11</b>
7.1 Contact Detection .....	13
<b>8 Technical Parameters .....</b>	<b>14</b>
8.1 P501 Probe .....	14
8.2 P503 Probe.....	17
<b>9 Information on Recycling and Disposal.....</b>	<b>20</b>
<b>10 Customer service .....</b>	<b>21</b>
<b>11 Warranty .....</b>	<b>22</b>

# 1 Declaration of Conformity

Manufacturer:  
Langer EMV-Technik GmbH

Nöthnitzer Hang 31  
01728 Bannewitz  
Germany



Langer EMV-Technik GmbH herewith declares that the

**P501 / P503 set**, RF Power Injection including  
P501, P503

conforms with the following relevant regulations:

- EMC Directive 2014/30/EU
- Low-Voltage Directive 2014/35/EU
- Restriction of certain Hazardous Substances 2011/65/EU

The following applicable standards were used to implement the requirements specified by the a forementioned directives:

- DIN EN IEC 61000-6-1:2019-11 (EMC immunity)
- DIN EN IEC 61000-6-3:2022-06 (EMC emission)
- DIN EN 61010-1:2020-03 (Safety)
- DIN EN IEC 63000:2019-05 (Restriction of hazardous substances)

Name of the person authorized to compile the technical

Katja Langer

Bannewitz, 2025-09-08

Signature:

A handwritten signature in black ink, consisting of a large, stylized 'K' followed by a series of loops and a final flourish.

K. Langer, Managing Director

## **2 General Information**

### **2.1 Storage of the User Manual**

This user manual enables the safe and efficient use of the P501 / P503 set. It must be kept close at hand and accessible to the user.

### **2.2 Reading and Understanding the User Manual**

Read the user manual carefully, observe the safety information (Chapter 3) and follow the instructions given in this manual before putting the device into service.

### **2.3 Local Safety and Accident Prevention Regulations**

The local accident prevention and general safety regulations also apply to ensure that the P501 / P503 set is used for its intended purpose.

### **2.4 Images**

Figures have been included in this user manual to assist the reader's understanding but may differ from the device's actual version.

### **2.5 Limitation of Liability**

In the following cases, Langer EMV-Technik GmbH can assume no liability for damage to property and personal injury if:

- The information given in this user manual has not been observed.
- P501 / P503 set was operated by staff not qualified in the field of EMC.
- P501 / P503 set was subjected to unauthorized modifications or technical changes.
- P501 / P503 set was not used according to its intended purpose.
- Spare parts or accessories were used that had not been approved by Langer EMV-Technik GmbH.

The actual scope of delivery may deviate from the illustrations and texts in this user manual due to the customization of orders or due to technical changes and innovations.

### **2.6 Errors and Omissions**



The information in this manual has been carefully checked and is believed to be accurate; however, the Langer EMV-Technik GmbH assumes no responsibility for any clerical, typographical, or proofreading errors, or omissions.

### **2.7 Copyright**

The content of this user manual is protected by copyright law and may only be used in connection with the P501 / P503 set. This user manual may not be used for any other purpose without the prior written approval of Langer EMV-Technik GmbH.

## 3 Safety

### 3.1 Labels and Signs

 <p>General warning sign</p>	 <p>Warning; Electricity</p>	 <p>Prohibition sign; No access for people with active implanted cardiac devices.</p>
<p>Table 1: Safety signs</p>		

Safety instructions in this user manual are marked by symbols (**Table 1**). Observe the safety precautions and act cautiously to avoid accidents as well as personal and material damages.

### 3.2 Intended Use

The P501 / P503 probe set is used for the conducted measurement of the immunity according to IEC 62132-4. Understanding the immunity parameters allows an IC optimization and the definition of application requirements. Available DPI couple networks (P501, P503) allow the RF coupling with different frequency ranges and different input voltages.

The P501 and P503 probes are built according to their specified use therefore they should be used only for the following purposes:

- Injection of RF power into IC pins or balls with the P501 or P503 within the given specifications.
- The P501 / P503 set must be used in conjunction with the ICE1 set from Langer EMV-Technik GmbH.

Any use beyond these specifications is considered contrary to the intended use.

### 3.3 Reasonably foreseeable Misuse



**Danger resulting from misuse!**

**Misuse of the P501 / P503 set can lead to dangerous situations!**

- Use of the product outside of the given specifications.
- Modification or changing of the product without consent of Langer EMV-Technik GmbH.
- Operating the product with a technical fault.

### 3.4 Staff Requisition

Only qualified staff with training, knowledge, and experience in the field of EMC is allowed to operate the P501 / P503 set.

Persons whose ability to perform is influenced or impaired by alcohol, drugs, or pharmaceuticals, are not allowed to operate the P501 / P503 set.

Certain functions may only be carried out by qualified personnel of Langer EMV-Technik GmbH.

### 3.5 Safety Instructions

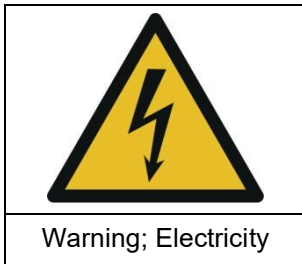

**Danger resulting from Electricity!**

**Risk of injury by electrocution!**

Only connect the high-voltage cable to the P500 probe before operation.  
Don't touch the probe tip of a P500 probe while it is in operation.

- If insulation is damaged, the power supply has to be disconnected immediately.
- Replace damaged parts with undamaged parts before operation. Contact Langer EMV-Technik GmbH for proper replacements.
- Protect live parts from moisture to avoid short circuits.  
Never leave a Langer EMV-Technik GmbH product unattended whilst this is in operation.



**Danger resulting from electro-magnetic fields!**

**Risk of affecting a cardiac device!**

Persons with a cardiac device, such as a pacemaker, are not allowed to work on or approach the P501 / P503 set whilst it is in operation.

## 4 Scope of delivery

Item	Designation	Type	Parameter	Quantity
1.	DPI coupling network up to 3 GHz	<b>P501</b>	50 V	1
2.	DPI coupling network up to 1 GHz	<b>P503</b>	50 V	1
3.	Power supply unit		12 V	1
4.	Double-shielded measurement cable	<b>SMA-SMA 1 m ds</b>		1
5.	Double-shielded measurement cable	<b>SMA-SMB 1 m ds</b>		2
6.	System case	<b>P500 case</b>		1
7.	Quick guide			1
8.	User manual			1

**Important:** The scope of delivery may deviate depending on the respective order.

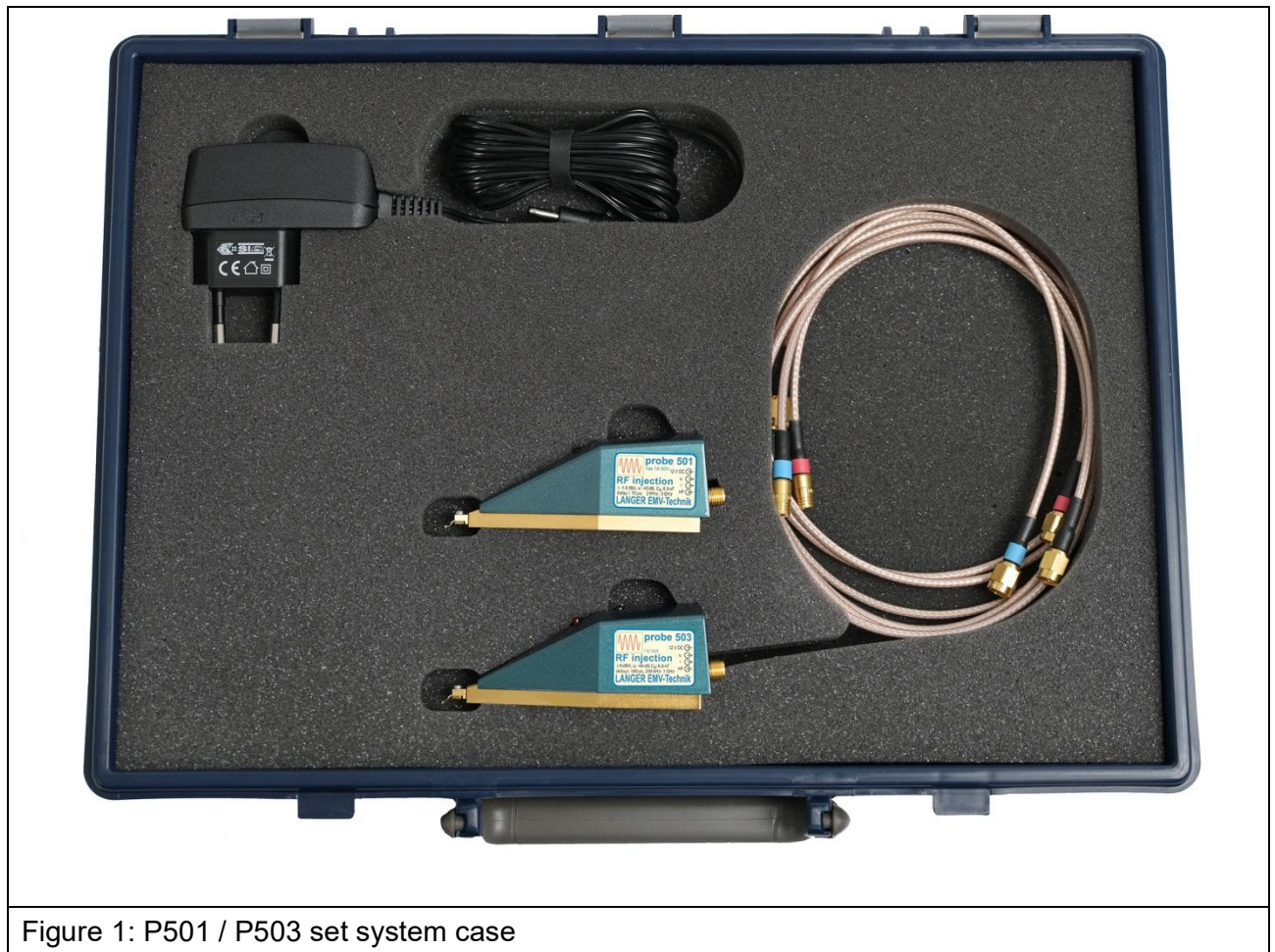

Figure 1: P501 / P503 set system case

## 5 P500 Probe Set

### 5.1 General Description

The P500 probe set is used to inject high-frequency currents and voltages into IC pins. The three probes are designed to work in conjunction with an RF power amplifier and an RF generator (see Chapter 6). They feature an integrated ammeter and a voltmeter.



Figure 2: P501 probe

The RF power is directed from the power amplifier through the P500 probe. Within the P500 probe nearby its tip is an RF voltmeter and ammeter. The time behaviour of the RF voltage and current can be measured and transmitted to an oscilloscope. Inside the oscilloscope the effective values and the phase angle are calculated from the time behaviour. Further calculations (power, impedance, FFT, etc.) are possible in accordance to the oscilloscope features.

The voltmeter and ammeter have constant and frequency dependant correction factors. The constant correction factors can be applied within the oscilloscope (for a realistic oscilloscope display).

Within the probe voltage and current are measured. Between the probe tip and the voltmeter and ammeter are substitution elements R, L, C. The conversion of voltage and current to the probe tip (IC pin) is necessary.

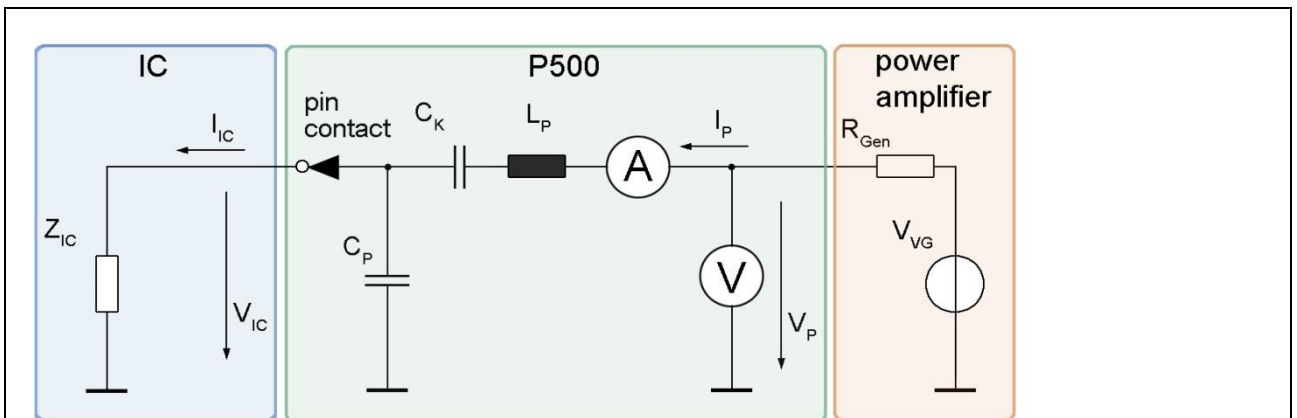

Figure 3: Equivalent circuit diagram for the measurement

## 5.2 Design and Function

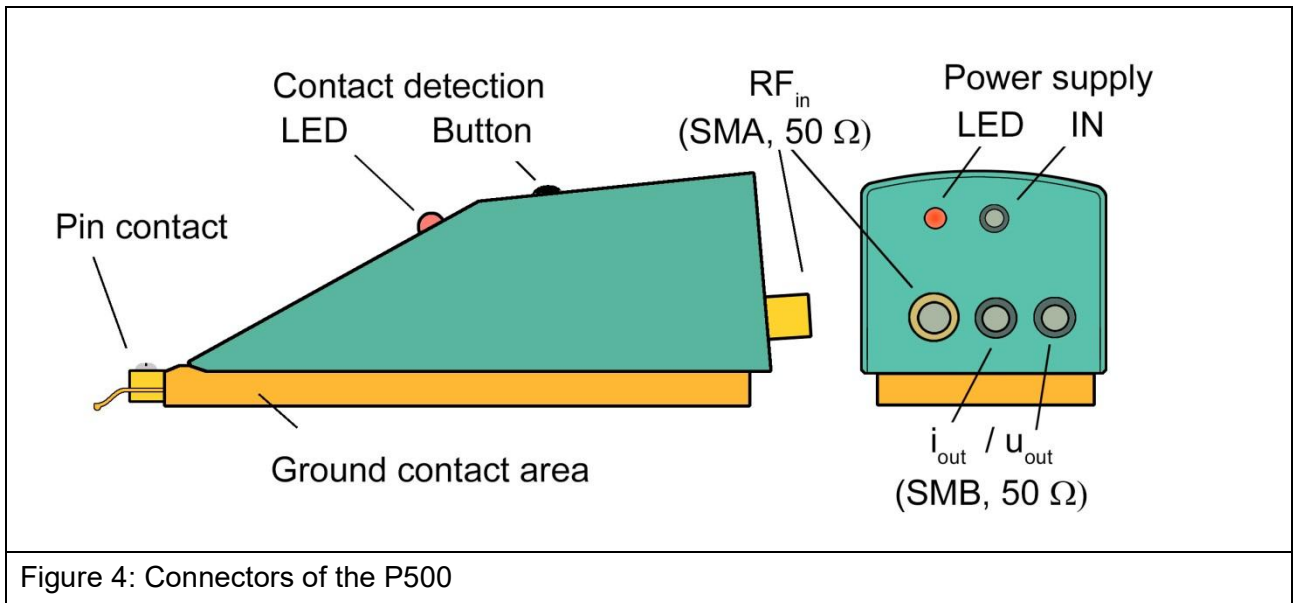

Figure 4: Connectors of the P500

The P500 includes a 50 Ohm RF-line from the  $RF_{in}$  (SMA) connector to the pin contact. Furthermore an internal voltmeter and ammeter are integrated in the probe. Thereby the exact values of the voltage and the current at the pin contact are quantifiable. The ground reference is established over the whole bottom surface (ground contact area).

The LED indicates DC power supply.

The button on top of the probe will activate the contact detection which is used to detect a galvanic connection of the probe tip with an IC pin. The LED is indicating the state of the contact detection.

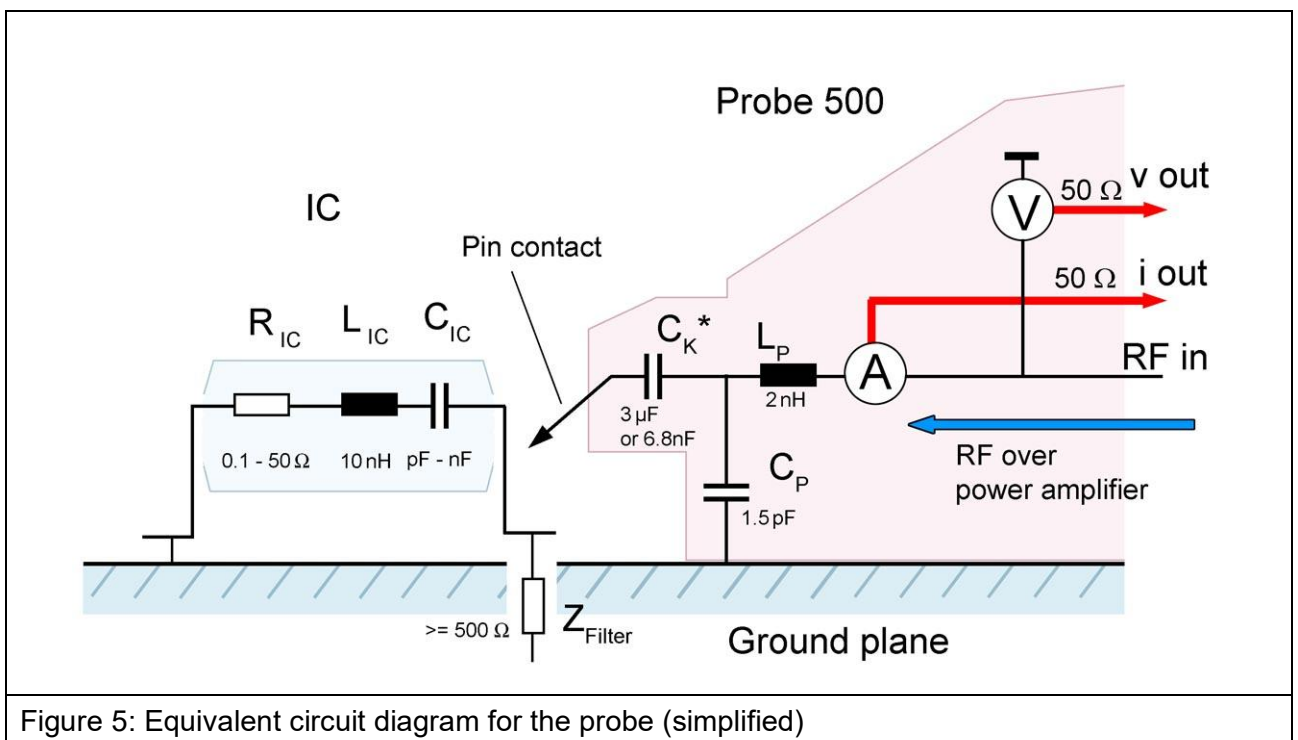

Figure 5: Equivalent circuit diagram for the probe (simplified)

\* customer specific -  $C_K$  refer to label on the respective probe

## 6 Operational Notes

- The test set-up should always be operated via a filtered power supply.
- **Attention! Functional near fields and interference emissions may occur when operating EMC test set-ups. The user is responsible for taking measures to prevent any interference to the correct function of products outside the EMC environment of the test set-up (in particular through radiated interference).**  
This can be achieved by:
  - observing an appropriate safety distance,
  - use of shielded or shielding rooms.
- The disturbances that are injected into the ICs can destroy (latch-up) the device under test if their intensity is too high. Protect the device under test by:
  - increasing the disturbance gradually and stopping when a functional fault occurs,
  - interrupting the power supply to the device under test in the event of a latch-up.
- **Attention! Make sure that internal functional faults are visible from outside. The device under test may be destroyed due to an increase in the injection intensity if the faults are not visible outside. Take the following measures as necessary:**
  - monitoring of representative signals in the device under test,
  - special test software,
  - visible reaction of the device under test to inputs (reaction test of the device under test).

We cannot assume any liability for the destruction of devices under test!

## 7 Measurement Set-Up

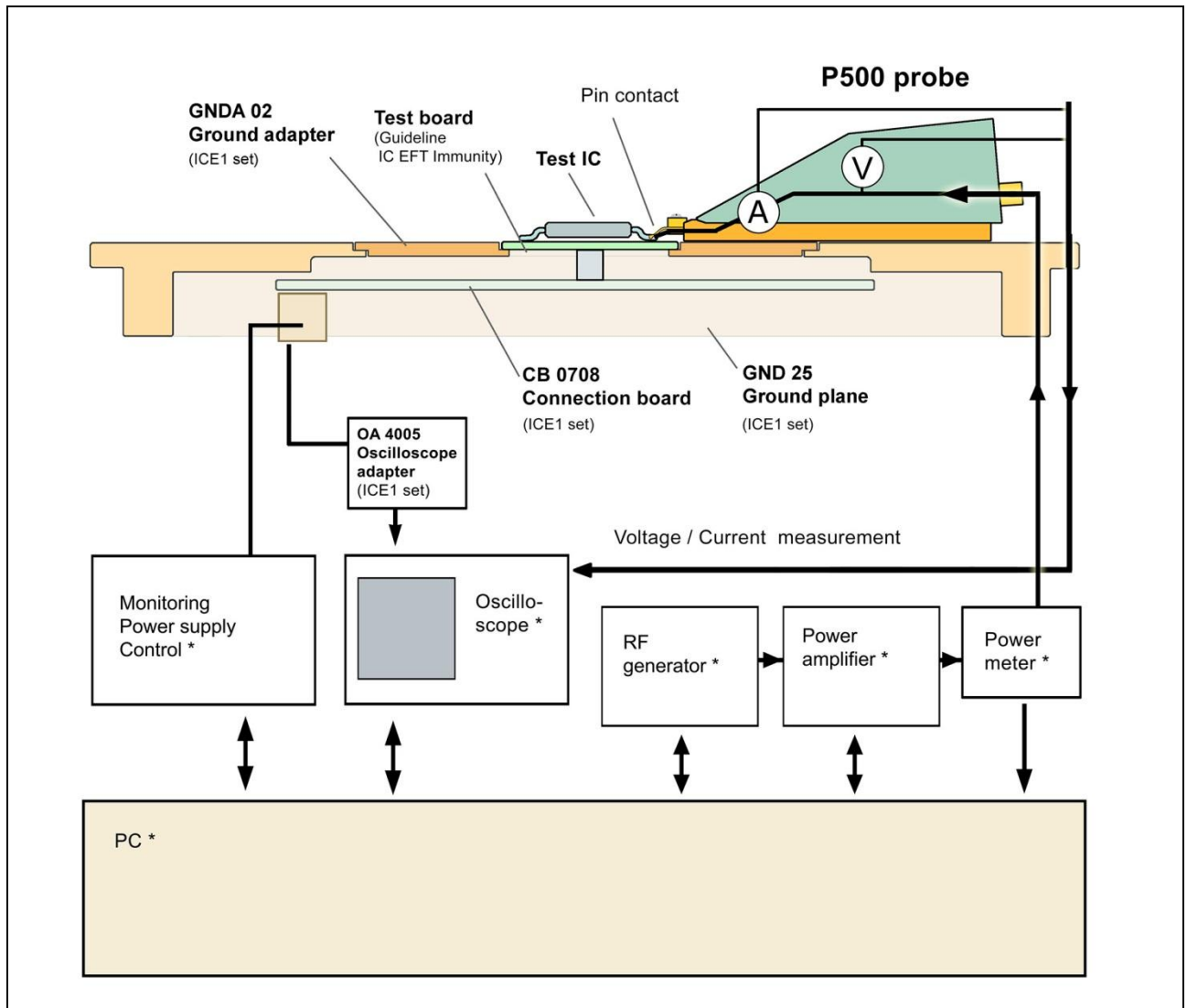

Figure 6: Measurement set-up with ICE1 set (The devices marked with \* are not included in the scope of delivery of the ICE1 set / P501 / P503 set.)

**Figure 6** shows the whole IC Test System schematically including the ICE1 IC test environment set. In this set-up the DUT (test IC) is connected to a special test board<sup>1</sup>. The test board is connected to the CB 0708 connection board. Both parts are put in the GND 25 ground plane. The P500 probe is magnetically fixed on this ground plane.

All IC pins of the DUT are contacted separately during the test procedure. Thereby a generated power is injected through the P500 into a pin of the DUT. The voltage ( $u$ ) and current ( $i$ ) at the P500 pin contact are measured with an oscilloscope.

This means that with this set-up measurements according to IEC 62132-4 are possible.

For details of the ICE1 set please see the appropriate user manual.

<sup>1</sup> For manufacturing of the test board: "Guideline IC EFT immunity", Langer EMV-Technik GmbH

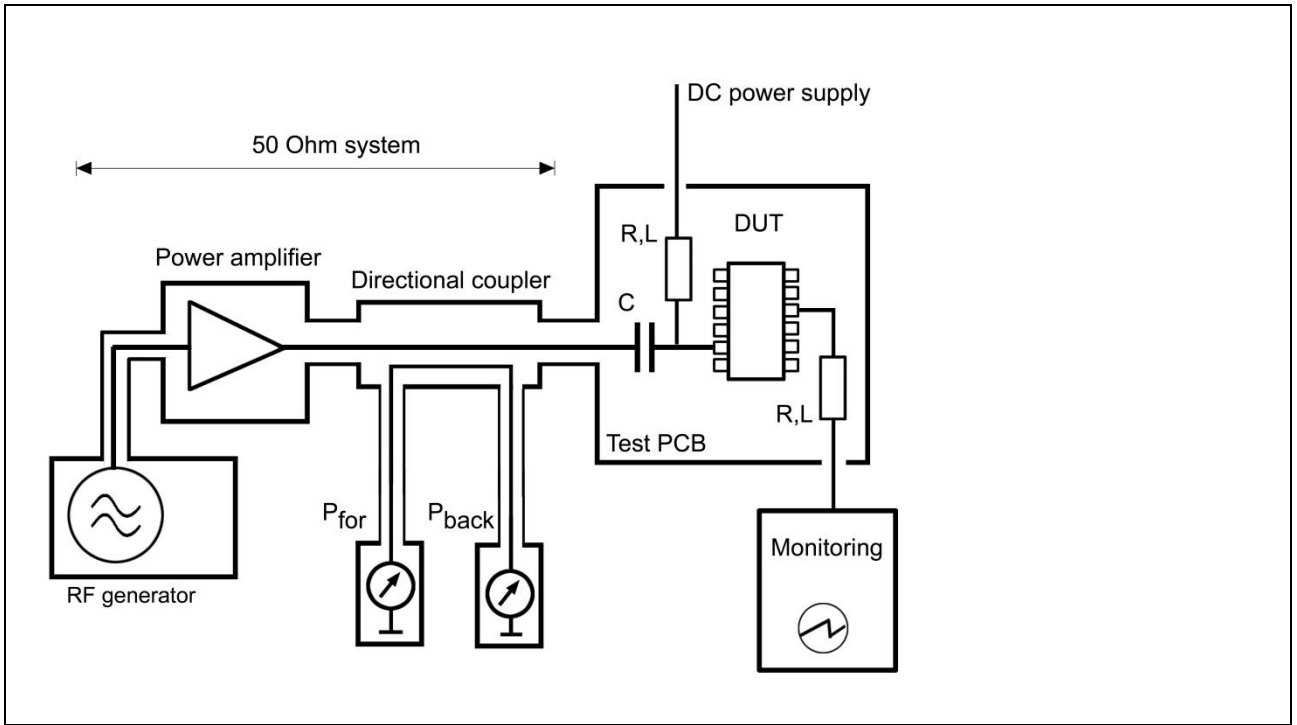

Figure 7: DPI measurement set-up according to IEC-62132-4

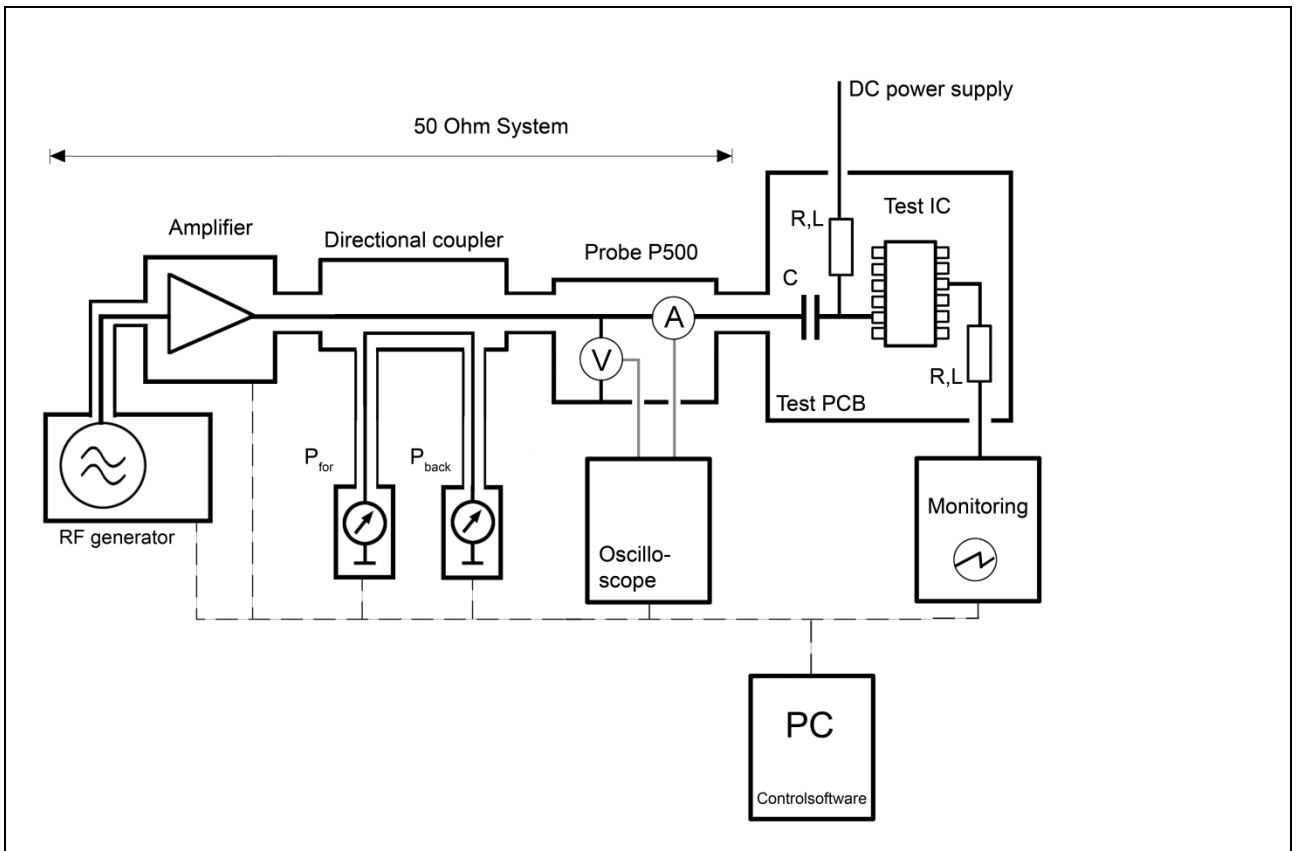
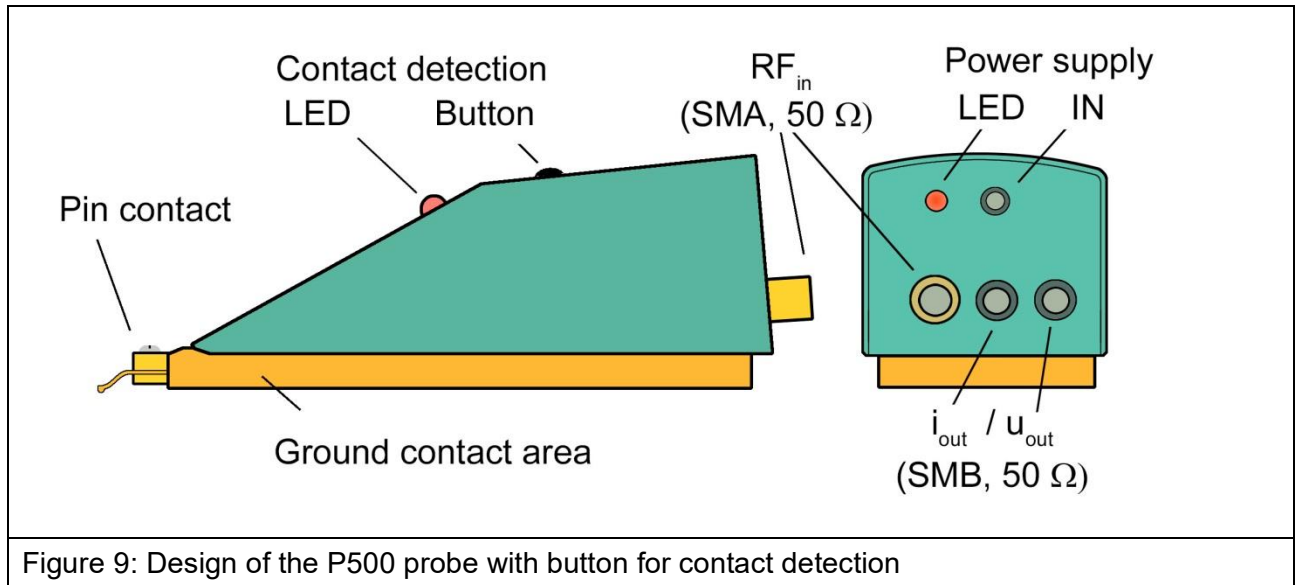

Figure 8: Measurement set-up of the DPI method with P500 probe

## 7.1 Contact Detection

The contact detection is used to detect a galvanic connection of the probe tip with an IC pin automatically.



The probe tip is forward biased to a potential of -5 V by pushing the button for contact detection. If there is a galvanic connection between the probe tip and the IC-pin then the voltage level on the probe tip decreases due to the structure of the internal IC circuit. The voltage drop is detected and the contact is indicated by the LED at the upper section of the probe housing.

**NOTE:** Not connected Pins (NC) can not be detected.

## 8 Technical Parameters

### 8.1 P501 Probe

<b>Voltmeter</b>	without amplifier
Transfer factor $V_{out}/V_{in}$	-40 dB
Frequency range	100 kHz – 3 GHz
Maximum voltage	50 V <sub>eff</sub>
<b>Ammeter</b>	with amplifier
Frequency range	2 MHz – 3 GHz
Current correction factor R [dBΩ]:	see Figure 10
<ul style="list-style-type: none"> <li>• 2 MHz – 50 MHz</li> <li>• 50 MHz – 3 GHz</li> </ul>	approx. 0 dBΩ (1 V/A)
Delay current to voltage	probe specific (see Figure 13)
Noise figure	4.5 dB
Coupling capacitance ( $C_K$ )	3 μF or 6.8 nF*
Supply voltage	12 V / DC
Table 2: P501 technical parameters	

\* customer specific -  $C_K$  refer to label on the respective probe

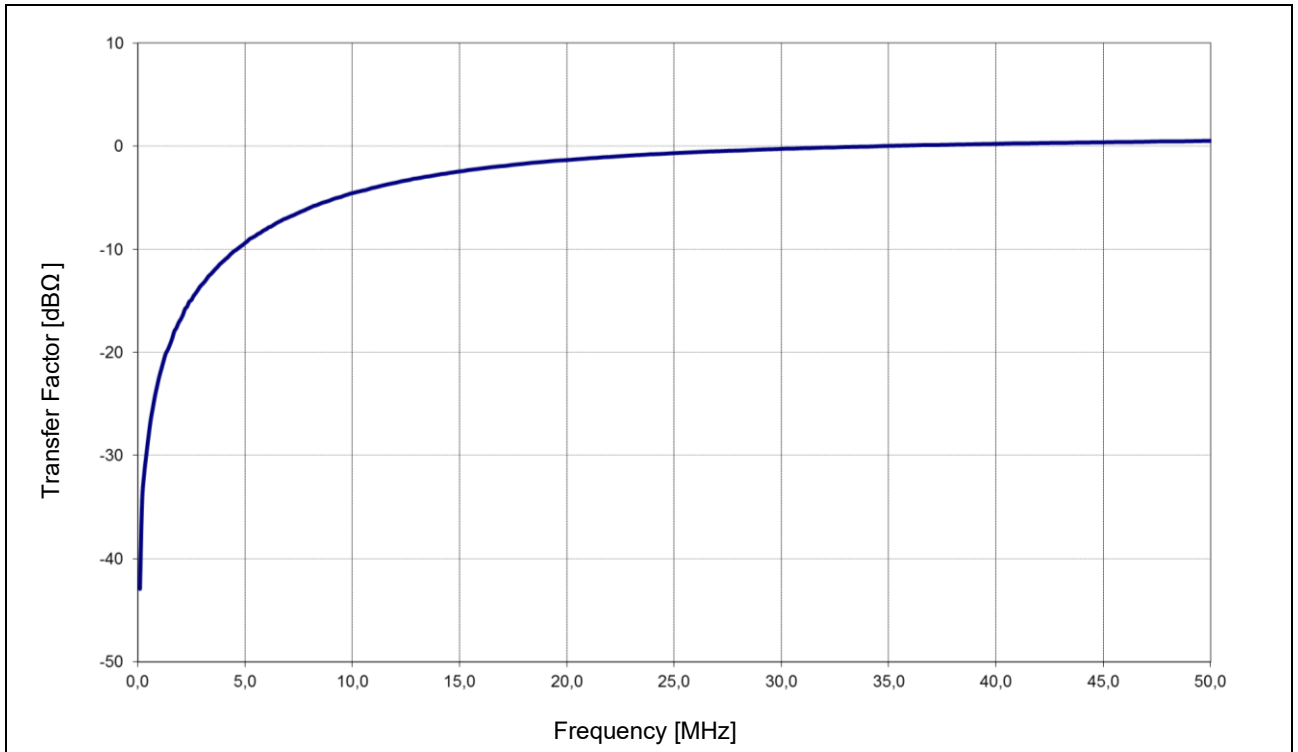

Figure 10: P501 ammeter characteristic 50 MHz

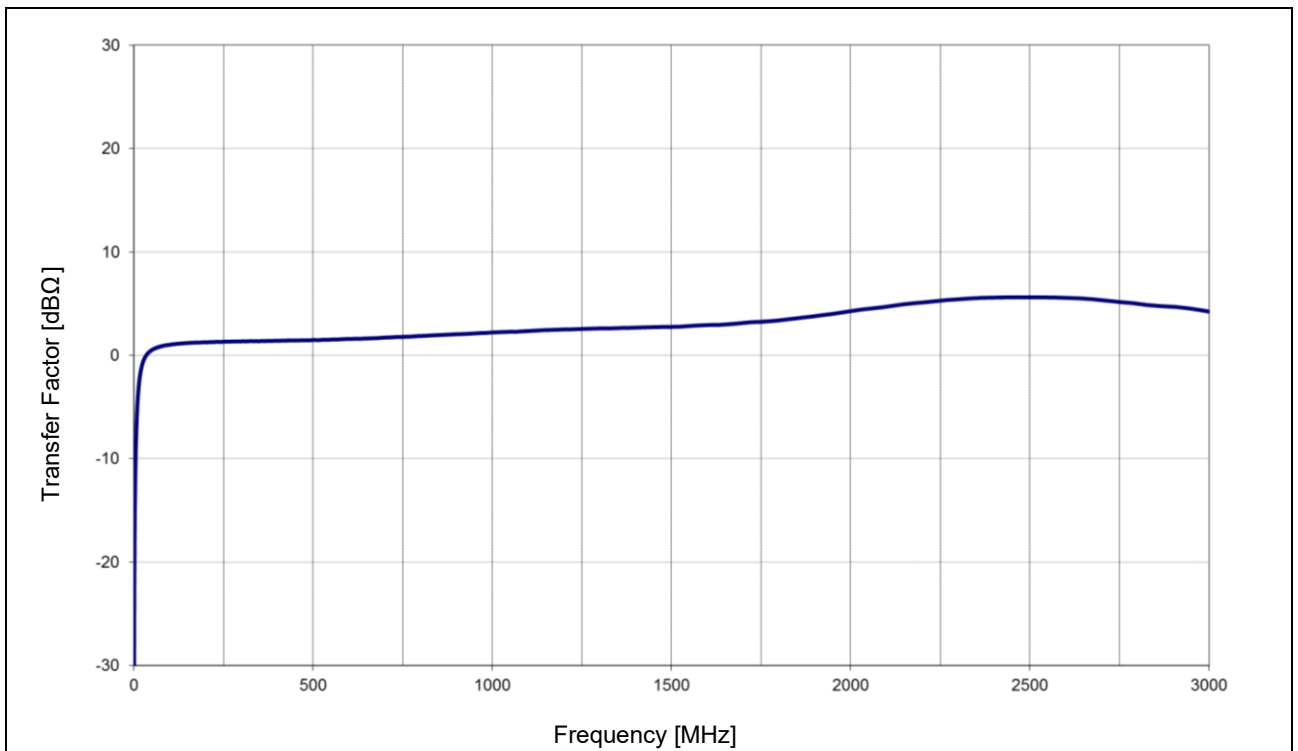

Figure 11: P501 ammeter characteristic 3 GHz

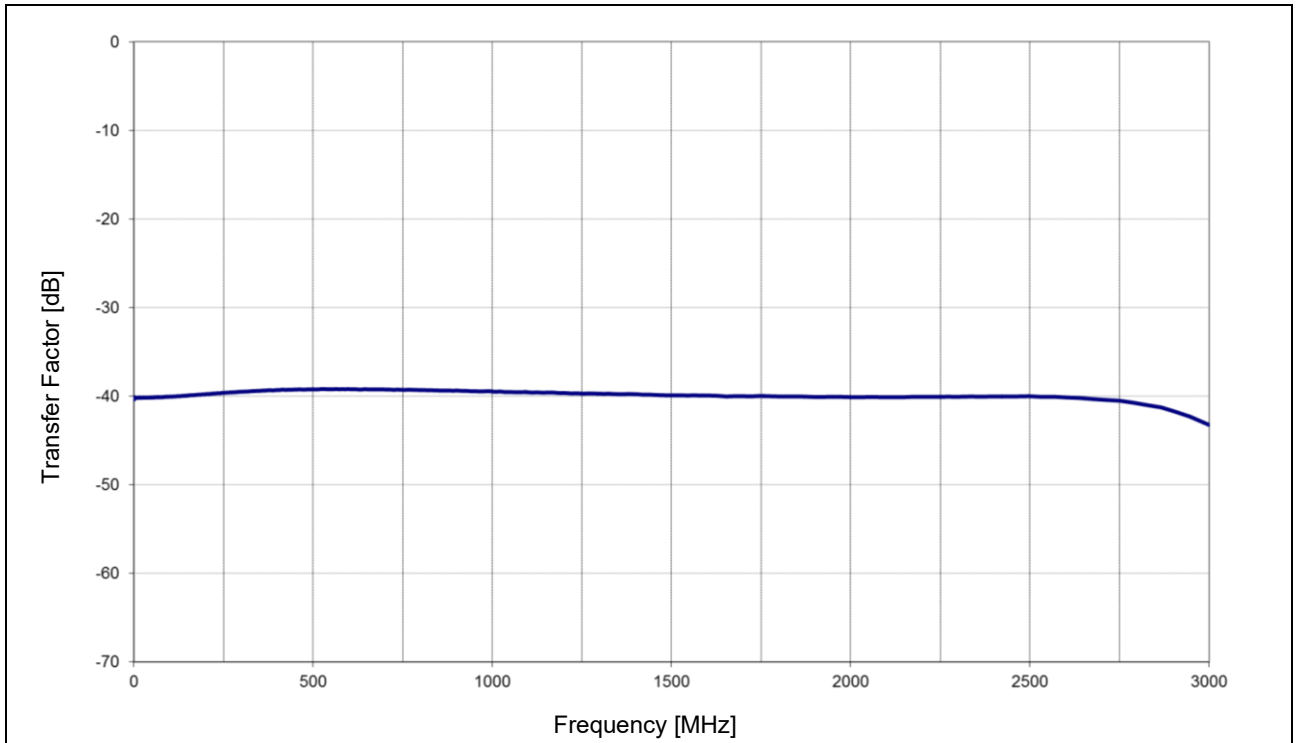

Figure 12: P501 voltmeter characteristic 3 GHz

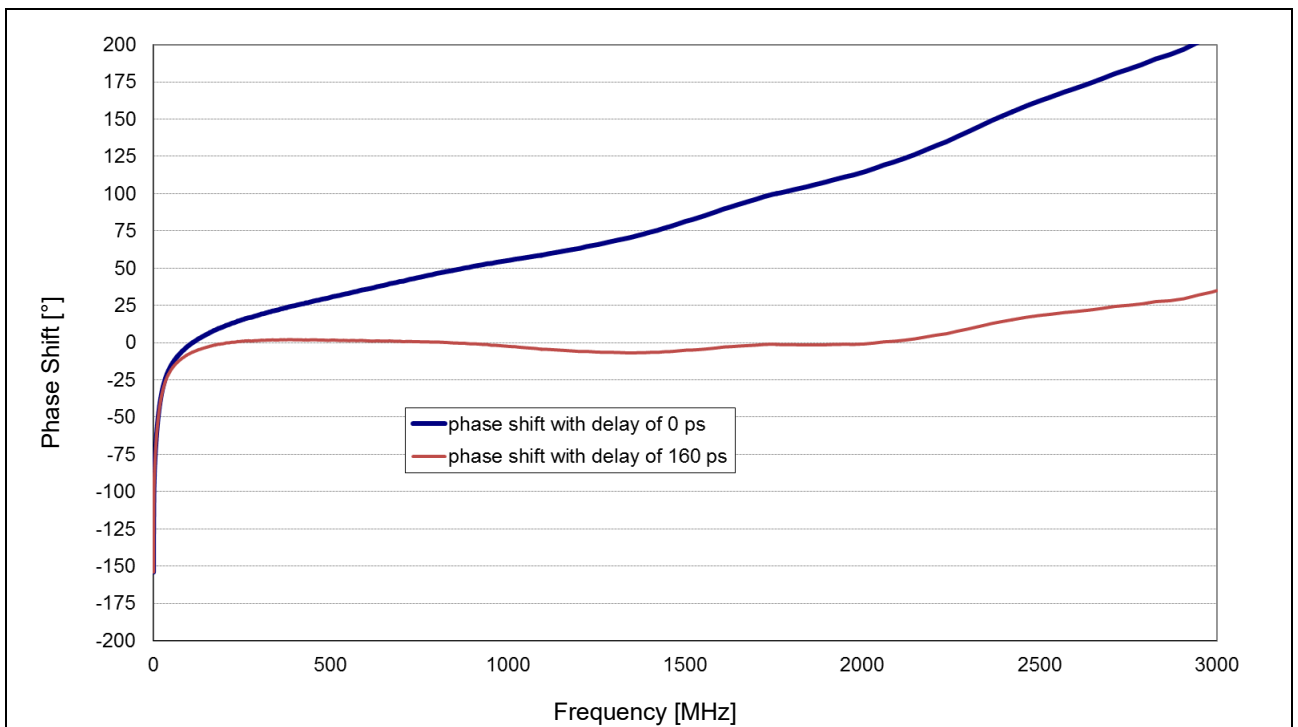

Figure 13: P501 phase characteristic 3 GHz; phase shift current in reference to voltage

## 8.2 P503 Probe

<b>Voltmeter</b>	without amplifier
Transfer factor $V_{out}/V_{in}$	-40 dB
Frequency range	100 kHz – 3 GHz
Maximum voltage	50 V <sub>eff</sub>
<b>Ammeter</b>	with amplifier
Frequency range	150 kHz – 1 GHz
Current correction factor R [dBΩ]:	
<ul style="list-style-type: none"> <li>• 150 kHz – 5 MHz</li> <li>• 5 MHz – 1 GHz</li> </ul>	see Figure 14
Delay current to voltage	approx. 0 dBΩ (1 V/A)
Noise figure	probe specific (see Figure 17)
	4.5 dB
Coupling capacitance ( $C_K$ )	3 μF or 6.8 nF*
Supply voltage	12 V / DC
Table 3: P503 technical parameters	

\* customer specific -  $C_K$  refer to label on the respective probe

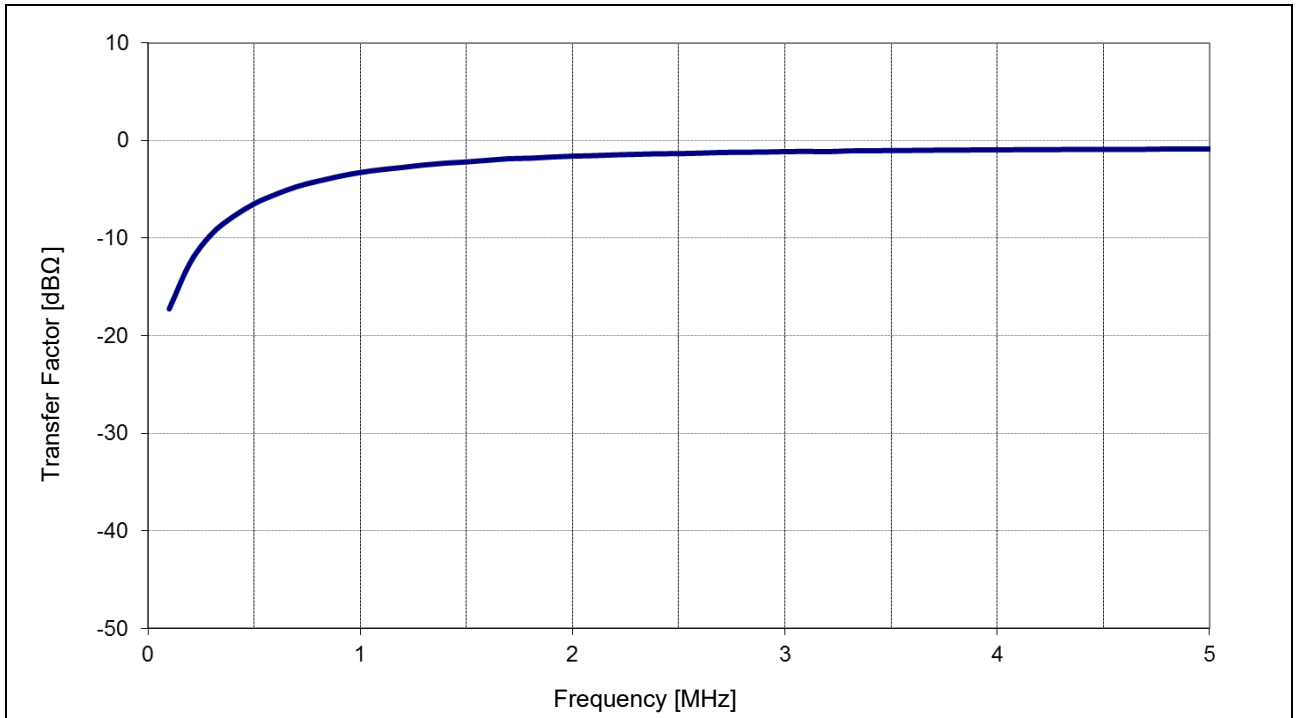

Figure 14: P503 ammeter characteristic 5 MHz

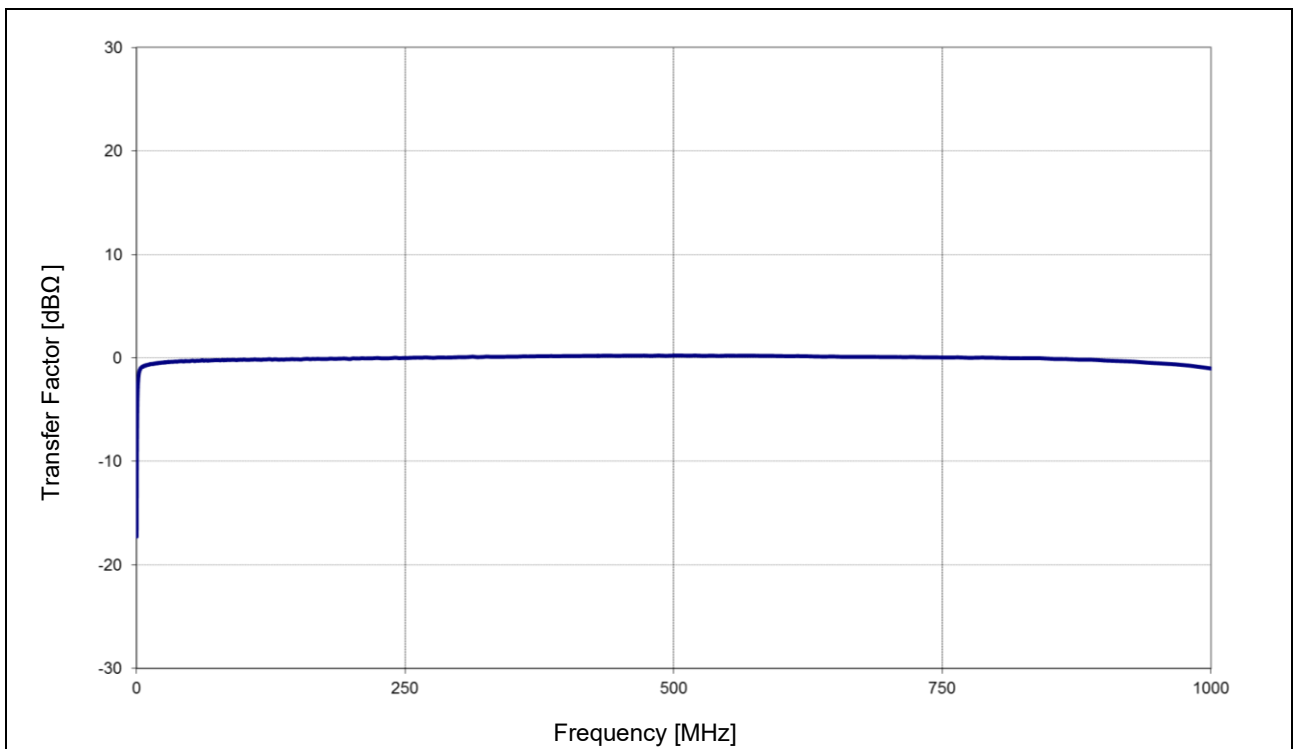

Figure 15: P503 ammeter characteristic 1 GHz

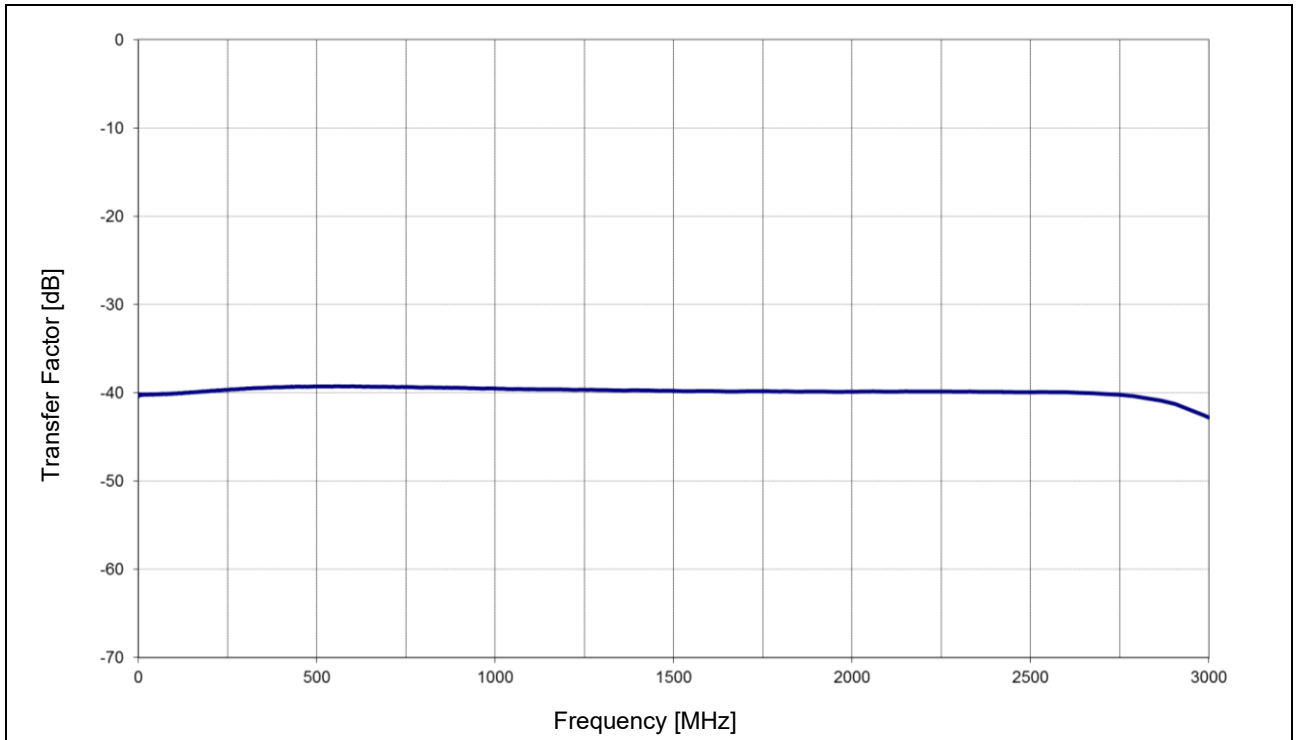

Figure 16: P503 voltmeter characteristic 3 GHz

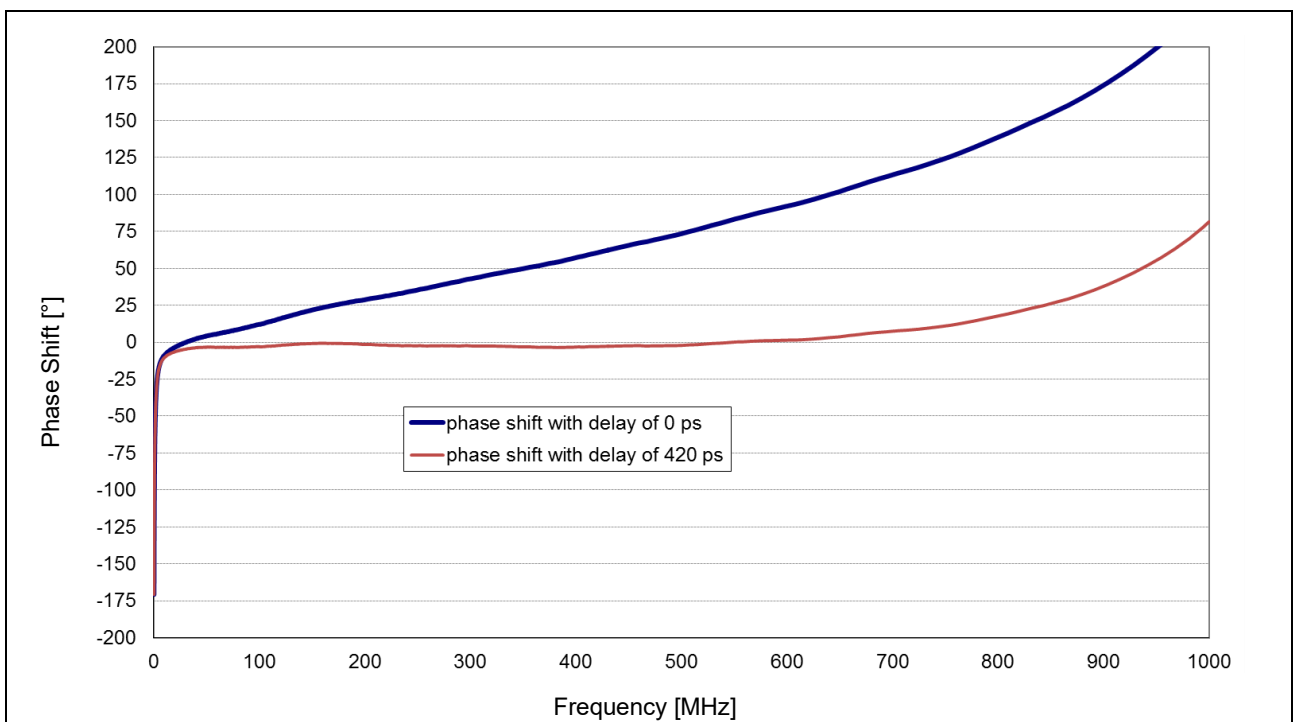
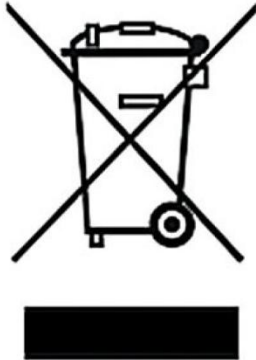

Figure 17: P503 phase characteristic 1 GHz; phase shift current in reference to voltage

## 9 Information on Recycling and Disposal



DE 80567526

In accordance with the WEEE Directive 2012/19/EU (Waste of Electrical and Electronic Equipment), the following must be observed:

At the end of its service life, this product should be taken to a suitable disposal facility for recycling and disposal. Do not dispose of with household waste.

## 10 Customer service

Please contact us if you have any questions, comments or suggestions.

You can contact us:

Monday – Friday

8:00 Uhr bis 15 Uhr (CET)

Contact us at:

Address: Langer EMV-Technik GmbH  
Nöthnitzer Hang 31  
01728 Bannewitz  
Germany

Internet: <https://www.langer-emv.com/>

E-mail: [sales@langer-emv.de](mailto:sales@langer-emv.de)

Phone: +49 (0) 351-430093-0

Fax: +49 (0) 351-430093-22

### Calibration

We recommend having the product calibrated every two years by the manufacturer Langer EMV-Technik GmbH or by a certified distributor.

## 11 Warranty

Langer EMV-Technik GmbH shall remedy all defects attributable to material or manufacturing faults within the statutory warranty period by repairing the product or supplying replacement parts.

**This guarantee is only granted on condition that:**

- the information and instructions in the operating instructions are observed.

**The guarantee expires if:**

- an unauthorized repair is carried out on the product
- the product is modified
- the product is not used as intended

This document may not be copied, reproduced or processed, duplicated or distributed using electronic systems, either in whole or in part, without the prior written permission of Langer EMV-Technik GmbH. The management of Langer EMV-Technik GmbH accepts no liability for damage resulting from the use of this printed information.