

LANGER
EMV-Technik

IC TEST SYSTEM

User manual

P331-2 set

ESD-Pulse Injection IEC 61000-4-2



Table of Contents	Page
1 Declaration of Conformity.....	3
2 General Information	4
2.1 Storage of the User Manual.....	4
2.2 Reading and Understanding the User Manual	4
2.3 Local Safety and Accident Prevention Regulations.....	4
2.4 Images	4
2.5 Limitation of Liability	4
2.6 Errors and Omissions	4
2.7 Copyright.....	4
3 Scope of delivery	5
4 Technical Parameters	6
4.1 P331-2 ESD generator	6
4.2 BPS 203 Burst Power Station.....	6
4.3 SM 02-01 Shunt.....	7
5 Safety.....	8
5.1 Labels and Signs.....	8
5.2 Intended Use	8
5.3 Reasonably foreseeable Misuse.....	8
5.4 Staff Requisition	9
5.5 Safety Instructions	9
6 P331-2 ESD Generator (IEC 61000-4-2).....	10
6.1 Design and Function of the P331-2 Probe	10
6.2 Characteristics.....	11
7 Operational Notes.....	12
8 System Set-Up	13
9 Verifying the Waveform.....	15
10 Information on Recycling and Disposal	16
11 Customer service.....	17
12 Warranty.....	18

1 Declaration of Conformity



Manufacturer:
Langer EMV-Technik GmbH

Nöthnitzer Hang 31
01728 Bannewitz
Germany

Langer EMV-Technik GmbH herewith declares that the

**P331-2 Set, ESD Pulse Injection acc. IEC 61000-4-2 including
P331-2; BPS 203; BPM 02**

conforms with the following relevant regulations:

- EMC Directive 2014/30/EU
- Low-Voltage Directive 2014/35/EU
- Restriction of certain Hazardous Substances 2011/65/EU

The following applicable standards were used to implement the requirements specified by the a forementioned directives:

- DIN EN IEC 61000-6-1:2019-11 (EMC immunity)
- DIN EN IEC 61000-6-3:2022-06 (EMC emission)
- DIN EN 61010-1:2020-03 (Safety)
- DIN EN IEC 63000:2019-05 (Restriction of hazardous substances)

Name of the person authorized to compile the technical

Katja Langer

Bannewitz, 2025-09-08

Signature:

A handwritten signature in black ink, appearing to be 'K. Langer', written over a horizontal line.

K. Langer, Managing Director

2 General Information

2.1 Storage of the User Manual

This user manual enables the safe and efficient use of the P331-2 set. It must be kept close at hand and accessible to the user.

2.2 Reading and Understanding the User Manual

Read the user manual carefully, observe the safety information (Chapter 5) and follow the instructions given in this manual before putting the device into service.

2.3 Local Safety and Accident Prevention Regulations

The local accident prevention and general safety regulations also apply to ensure that the P331-2 set is used for its intended purpose.

2.4 Images

Figures have been included in this user manual to assist the reader's understanding but may differ from the device's actual version.

2.5 Limitation of Liability

In the following cases, Langer EMV-Technik GmbH can assume no liability for damage to property and personal injury if:

- The information given in this user manual has not been observed.
- P331-2 set was operated by staff not qualified in the field of EMC.
- P331-2 set was subjected to unauthorized modifications or technical changes.
- P331-2 set was not used according to its intended purpose.
- Spare parts or accessories were used that had not been approved by Langer EMV-Technik GmbH.

The actual scope of delivery may deviate from the illustrations and texts in this user manual due to the customization of orders or due to technical changes and innovations.

2.6 Errors and Omissions

The information in this manual has been carefully checked and is believed to be accurate; however, the Langer EMV-Technik GmbH assumes no responsibility for any clerical, typographical, or proofreading errors, or omissions.

2.7 Copyright

The content of this user manual is protected by copyright law and may only be used in connection with the P331-2 set. This user manual may not be used for any other purpose without the prior written approval of Langer EMV-Technik GmbH.

3 Scope of delivery

Item	Designation	Type	Parameter	Pcs.
01	ESD Generator (probe)	P331-2		1
02	Burst Power Station	BPS 203		1
03	Control software	BPS 203-Client		1
04	Shunt	SM 02-01	0.1 R	1
05	Control cable	FBK 12P 1 m		1
06	High-voltage cable	HV FI-FI 1 m		1
07	USB cable type A-B	USB-AB		1
08	Measuring cable	SMA-SMB 1 m		1
09	Power supply unit		12 V / 1 A	1
10	System case	P331 case		1
11	User manual			1
12	Quick guide			1

Important: The scope of delivery may deviate depending on the respective order.



4 Technical Parameters

4.1 P331-2 ESD generator

Frequency range	0.1 Hz – 10 Hz
Voltage range	100 V – 6 kV
Pulse form	0.7 / 60 ns
Energy storage capacity	150 pF
Internal resistance	330 Ω
Weight	0.25 kg
Sizes (L x W x H)	(79 x 41 x 40) mm

Table 1: P331-2 technical parameters

4.2 BPS 203 Burst Power Station

Frequency range	0.1 Hz – 30 Hz
Output voltage	± (0.1 ... 6) kV
Supply voltage	12 V / 1 A DC
Interface	USB
Control software	BPS 203-Client
Weight	350 g
Sizes (L x W x H)	(175 x 122 x 61) mm

Table 2: BPS 203 technical parameters



4.3 SM 02-01 Shunt

Frequency range	DC – 3 GHz
Input resistance	0.1 Ω
Output resistance	50 Ω
Correction factor	26 dB
Single pulse capacity 5/50 ns, 1/60 ns	360 A
Table 3: SM 02-01 technical parameters	

Burst sequences IEC 61000-4-4	5/50 ns
Burst repetition	300 ms
Impulses per burst	100
Pulse frequency	500 kHz
Current	150 A
Table 4: SM 02-01 continuous power rating	

5 Safety

5.1 Labels and Signs

 <p>General warning sign</p>	 <p>Warning; Electricity</p>	 <p>Prohibition sign; No access for people with active implanted cardiac devices.</p>
<p>Table 5: Safety signs</p>		

Safety instructions in this user manual are marked by symbols (**Table 5**). Observe the safety precautions and act cautiously to avoid accidents as well as personal and material damages.

5.2 Intended Use

The P331-2 set is used for conducted coupling of ESD pulses into ICs. The P331-2 probe sizing orientates itself by mechanisms of the ESD coupling into electronic assemblies (according to IEC 61000-4-2 / HMM¹). The BPS 203 burst power station supplies and controls the probe.

The P331-2 probe and BPS 203 burst power station are built according to their specified use therefore they should be used only for the following purposes:

- Injection of ESD pulses into IC pins or balls with P331-2 powered by BPS 203.
- Control of the P331-2 via BPS 203-Client or DLL.
- The P331-2 set must be used in conjunction with the ICE1 set from Langer EMV-Technik GmbH.

Any use beyond these specifications is considered contrary to the intended use.

5.3 Reasonably foreseeable Misuse



Danger resulting from misuse!

Misuse of the P331-2 set can lead to dangerous situations!

- Use of the product outside of the given specifications.
- Modification or changing of the product without consent of Langer EMV-Technik GmbH.
- Operating the product with a technical fault.

¹ HMM – Human Metal Model

5.4 Staff Requisition

Only qualified staff with training, knowledge, and experience in the field of EMC is allowed to operate the P331-2 set.

Persons whose ability to perform is influenced or impaired by alcohol, drugs, or pharmaceuticals, are not allowed to operate the P331-2 set.

Certain functions may only be carried out by qualified personnel of Langer EMV-Technik GmbH.

5.5 Safety Instructions

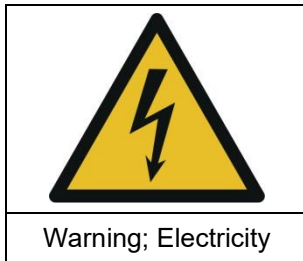

Danger resulting from Electricity!

Risk of injury by electrocution!

Only connect the high-voltage cable to the P331-2 probe before operation.

Don't touch the probe tip of a P331-2 probe while it is in operation.

- If insulation is damaged, the power supply has to be disconnected immediately.
 - Replace damaged parts with undamaged parts before operation. Contact Langer EMV-Technik GmbH for proper replacements.
 - Protect live parts from moisture to avoid short circuits.
- Never leave a Langer EMV-Technik GmbH product unattended while this is in operation.



Danger resulting from electromagnetic fields!

Risk of affecting a cardiac device!

Persons with a cardiac device, such as a pacemaker, are not allowed to work on or approach the P331-2 set while it is in operation.

6 P331-2 ESD Generator (IEC 61000-4-2)

The probe is used to generate standard ESD pulses according to IEC 61000-4-2 for ESD injection into the device under test via conductors (**Figure 2: P331-2 pulse form**).

The P331-2 probe allows the user to couple ESD into IC pins via conductors according to the standard IEC 61000-4-2 both directly and indirectly via coupling networks (standard). Coupling networks are used for coupling into interface connections or special high-speed interfaces such as USB, LVDS, Ethernet, etc. Inductive or capacitive couplers are suitable coupling networks (Information: Langer EMV-Technik GmbH).

6.1 Design and Function of the P331-2 Probe

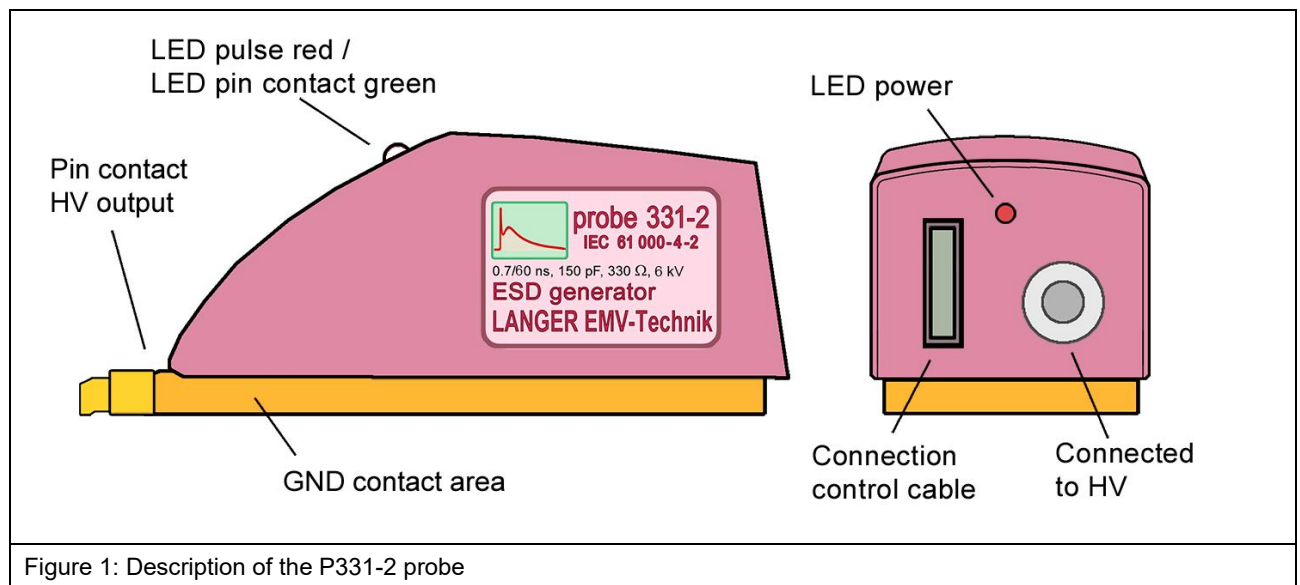

Figure 1: Description of the P331-2 probe

The pin contact is the P331-2 probe's high-voltage (HV) output that is used to inject the ESD pulse into the test IC.

The test pulse is generated in the probe through a high-voltage switch and the coupling networks that are required by the standard (**Figure 2**). The high voltage that is needed for the pulse generation is generated in the BPS 203 and led to the HV port of the P331-2 probe via a high-voltage cable. The BPS 203 controls the P331-2 probe. The signals are led to the control cable port via a control cable. The pulse/contact LED indicates when an ESD pulse is triggered and the device under test is contacted. The LED lights up green as soon as there is a galvanic connection between the pin contact and the device under test. A red light signals the triggered pulses.

The Power LED signals the P331-2 probe's power supply. The probe's GND contact area ensures low impedance, all-over contact with the GND 25 ground plane. Magnets that are integrated in the probe hold it on the ground plane.

6.2 Characteristics

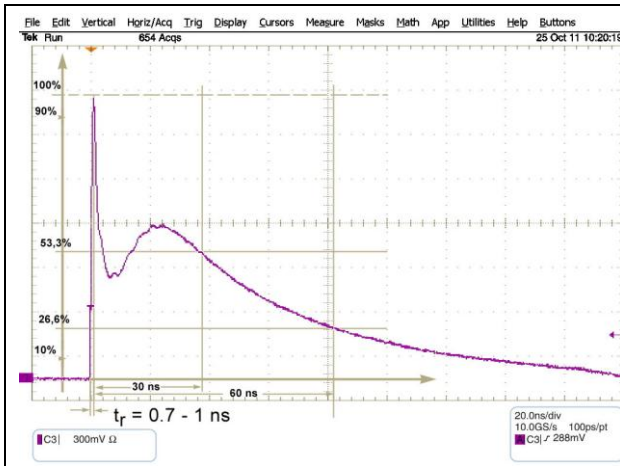

Figure 2: P331-2 pulse form

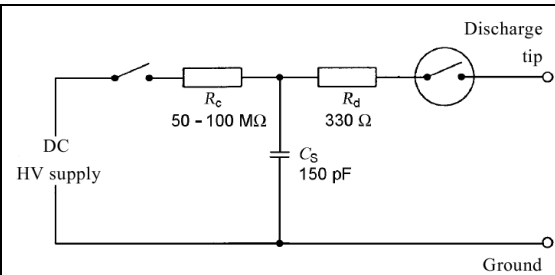

Figure 3: P331-2 equivalent circuit diagram

The ESD pulse is characterized by its current characteristic which is shown in **Figure 2**. **Figure 3** shows the equivalent circuit diagram of the P331-2 probe. Both are in accordance with the standard IEC 64000-4-2. Please refer to **Table 6** for the respective waveform parameters.

HV [kV]	I (max) [A] +/- 10%	I (30 ns) [A] +/- 30%	I (60 ns) [A] +/- 30%
0.5	1.86	1	0.5
1	3.72	2	1
2	7.5	4	2
4	15	8	4
6	22.5	12	6

Table 6: Waveform parameters

The respective short-circuit peak current can be calculated on the basis of the generator voltage U_{VG} when the probe is in operation.

$$I_P = U_{VG} \cdot K \quad \text{where: } K = 3.7 \text{ A / kV}$$

The equation reveals that the probe supplies 3.7 A per kV of the generator voltage.

Note: The pulse form is only guaranteed if the P331-2 probe is operated at a **minimum voltage of 200 Volt**.

7 Operational Notes

- The test set-up should always be operated via a filtered power supply.
- **Attention! Functional near fields and interference emissions may occur when operating EMC test set-ups. The user is responsible for taking measures to prevent any interference to the correct function of products outside the EMC environment of the test set-up (in particular through radiated interference).**
This can be achieved by:
 - observing an appropriate safety distance,
 - use of shielded or shielding rooms.
- The disturbances that are injected into the ICs can destroy (latch-up) the device under test if their intensity is too high. Protect the device under test by:
 - increasing the disturbance gradually and stopping when a functional fault occurs,
 - interrupting the power supply to the device under test in the event of a latch-up.
- **Attention! Make sure that internal functional faults are visible from outside. The device under test may be destroyed due to an increase in the injection intensity if the faults are not visible outside. Take the following measures as necessary:**
 - monitoring of representative signals in the device under test,
 - special test software,
 - visible reaction of the device under test to inputs (reaction test of the device under test).

We cannot assume any liability for the destruction of devices under test!

8 System Set-Up

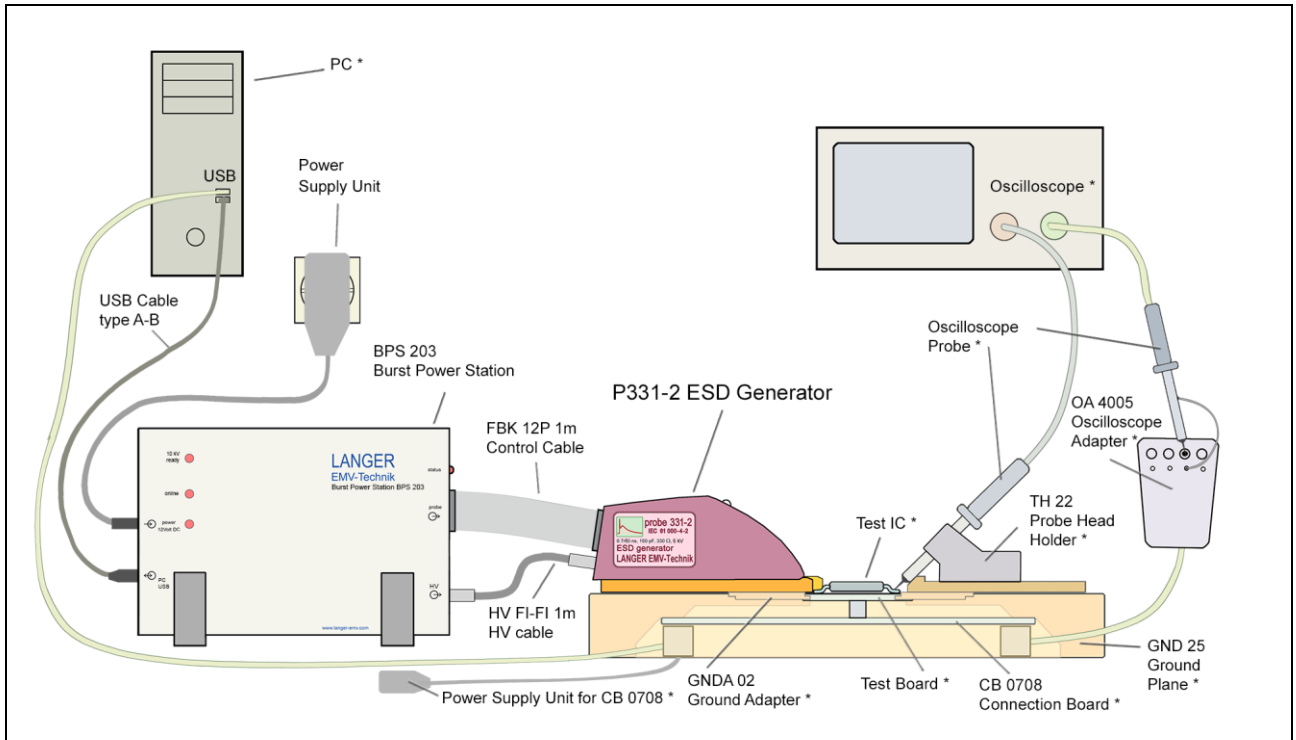

Figure 4: System set-up with P331-2 probe and the ICE1 set

The components marked with an asterisk (*) are not included in the scope of delivery.

Figure 4 shows the set-up of the IC test system with the ICE1 set² (Fehler! Verweisquelle konnte nicht gefunden werden.) and the P331-2 set. The BPS 203 burst power station generates a high voltage and supplies this to the P331-2's HV input via the HV FI-FI 1 m cable. In addition, the BPS 203 also controls the P331-2 via the FBK 12P 1m control cable. The PC in turn controls the BPS 203 via the USB-AB cable. The BPS 203-Client software is installed on the PC.

The ESD current pulse is generated from the high voltage in the P331-2 probe (**Figure 3**). The current pulse (**Figure 2**) flows into the test IC when contact to the pin is made.

The test IC is mounted on a special test board³. The test board is inserted into the GND 25 ground plane and connected to the CB 0708 connection board.

The ground plane and the connection board are integral parts of the ICE1 set. The evaluation of signals from the test IC may require external devices such as an oscilloscope or special test hardware (**Figure 5**).

² For details of the ICE1 set please see the appropriate user manual.

³ For manufacturing of the test board: "Guideline IC EFT immunity", Langer EMV-Technik GmbH

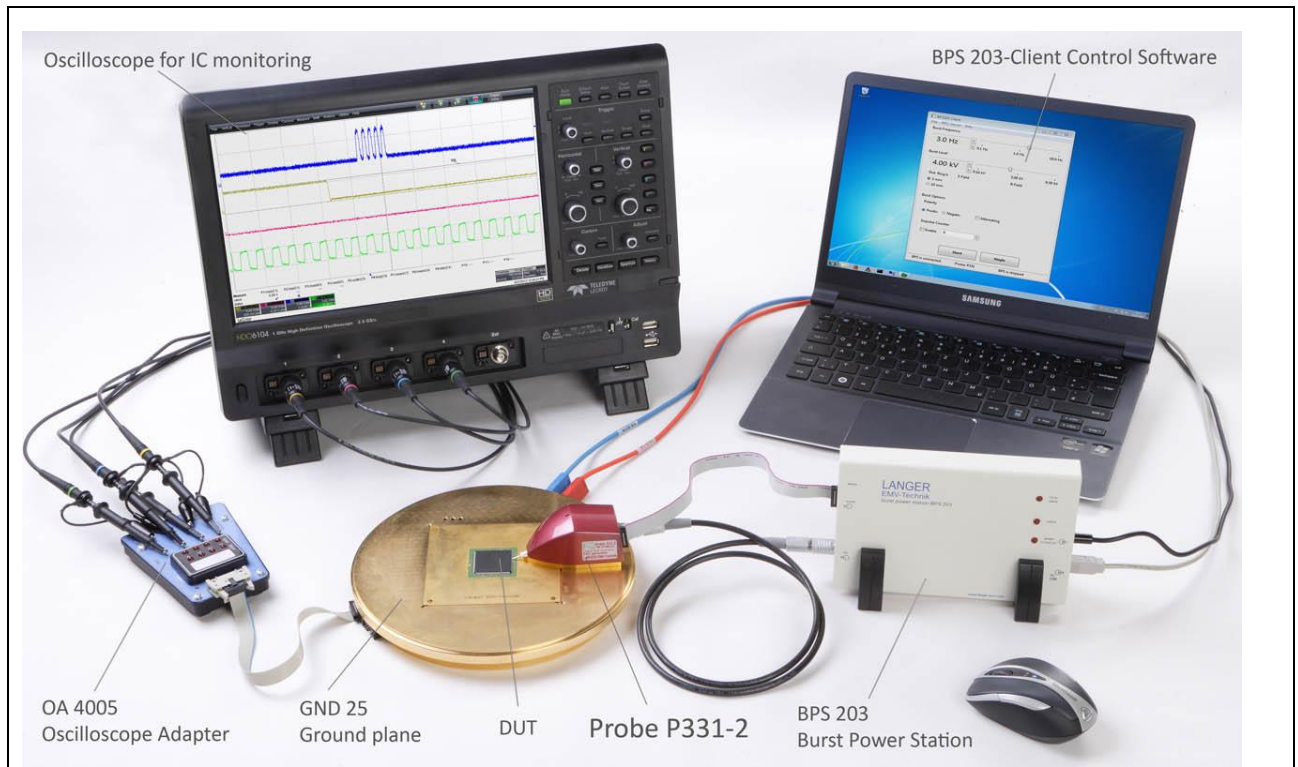

Figure 5: Test set-up with the P331-2 set and ICE1 set

The tasks and devices listed in the table below are described in their respective manuals:

Tasks and Devices	Manuals
<ul style="list-style-type: none"> • Instructions for the development of the test board • Test process 	<p>Guide line IC EFT immunity (Langer EMV-Technik GmbH)</p>
<ul style="list-style-type: none"> • GND 25 ground plane • CB 0708 connection board • OA 4005 oscilloscope adapter • TH 22 probe head holder • Monitoring and controlling the test IC 	<p>ICE1 set user manual</p>

Table 7

9 Verifying the Waveform

The SM 02-01 shunt can be used to verify the waveform of the current pulse. The shunt has a bandwidth of 3 GHz and can be loaded with a maximum pulse current of 180 A in the single-pulse mode of the BPS 203.

The shunt is inserted into the GNDA 02 ground adapter (**Figure 6**). The SMA output is connected to the 50R input of an oscilloscope with a corresponding bandwidth. The oscilloscope's attenuator is set to 26 dB (x20). 1 V at the display corresponds to a current of 1 A in the probe. When using an oscilloscope with a bandwidth > 3 GHz, please note that this is limited to 3 GHz.

The waveform has to be verified prior to every major measuring job. Provided the waveform does not deviate from the given parameters, the P331-2 probe only has to be calibrated every two years by Langer EMV-Technik GmbH.

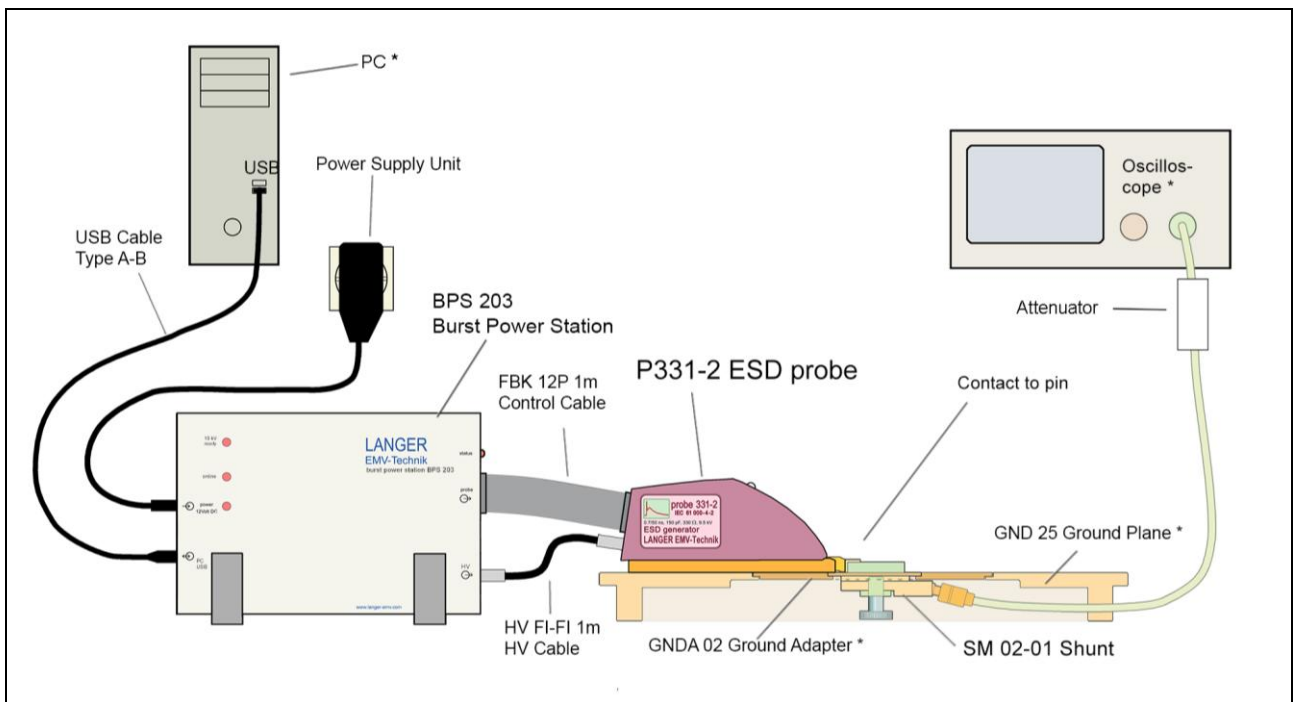

Figure 6: Measurement set-up with P331-2 and SM 02-01 to verify the pulse form

10 Information on Recycling and Disposal



DE 80567526

In accordance with the WEEE Directive 2012/19/EU (Waste of Electrical and Electronic Equipment), the following must be observed:

At the end of its service life, this product should be taken to a suitable disposal facility for recycling and disposal. Do not dispose of with household waste.

11 Customer service

Please contact us if you have any questions, comments or suggestions.

You can contact us:

Monday – Friday

8:00 Uhr bis 15 Uhr (CET)

Contact us at:

Address: Langer EMV-Technik GmbH
Nöthnitzer Hang 31
01728 Bannewitz
Germany

Internet: <https://www.langer-emv.com/>

E-mail: sales@langer-emv.de

Phone: +49 (0) 351-430093-0

Fax: +49 (0) 351-430093-22

Calibration

We recommend having the product calibrated every two years by the manufacturer Langer EMV-Technik GmbH or by a certified distributor.

12 Warranty

Langer EMV-Technik GmbH shall remedy all defects attributable to material or manufacturing faults within the statutory warranty period by repairing the product or supplying replacement parts.

This guarantee is only granted on condition that:

- the information and instructions in the operating instructions are observed.

The guarantee expires if:

- an unauthorized repair is carried out on the product
- the product is modified
- the product is not used as intended

This document may not be copied, reproduced or processed, duplicated or distributed using electronic systems, either in whole or in part, without the prior written permission of Langer EMV-Technik GmbH. The management of Langer EMV-Technik GmbH accepts no liability for damage resulting from the use of this printed information.