

LANGER
EMV-Technik

IC TEST SYSTEM

User Manual

P202 / P302 L-EFT set Direct EFT Pulse Injection



Table of contents:	Page
1 Declaration of Conformity	4
2 General Information	5
2.1 Storage of the User Manual	5
2.2 Reading and Understanding the User Manual	5
2.3 Local Safety and Accident Prevention Regulations	5
2.4 Images	5
2.5 Limitation of Liability	5
2.6 Errors and Omissions	5
2.7 Copyright	5
3 Safety	6
3.1 Labels and Signs	6
3.2 Intended Use.....	6
3.3 Reasonably foreseeable Misuse	6
3.4 Staff Requisition	7
3.5 Safety Instructions	7
4 Scope of delivery	8
5 Technical Parameters	9
5.1 P202	9
5.2 P302	9
5.3 BPS 202.....	10
5.4 BPS 202-Client	10
5.5 Operating Requirements	10
6 Design and Operating Principle	11
6.1 Overview	11
6.2 Additional Equipment	11
6.3 Description	12
6.4 BPS 202.....	13
6.4.1 Connections and LEDs of BPS 202.....	13
6.5 Pulse Generators	15
6.5.1 Overview	15
6.5.2 Status and Generator LED	16
6.5.3 P202 Pulse Current Generator	17
6.5.4 P302 Pulse Voltage Generator	19

7	Set-up and Commissioning	21
7.1	Description	21
7.2	Quick Start	21
7.2.1	ICE1 set.....	21
7.2.2	P202 / P302 set.....	21
8	BPS 202-Client Software	23
8.1	Requirements.....	23
8.2	Installation.....	23
8.3	General Notes.....	23
8.4	Setting of the Operating Mode	24
8.5	Pulse Configuration.....	25
8.5.1	Setting of the Pulse Frequency or the Pulse Period	25
8.5.2	Setting of the Pulse Level.....	25
8.6	Setting of the Pulse Polarity	25
8.7	Burst Configuration	26
8.7.1	Setting the Number of Pulses per Burst.....	26
8.7.2	Setting of the Burst Period.....	26
8.8	Setting of a Defined Pulse Counter or Timer	26
8.9	Setting of the External Trigger.....	27
8.10	Start Pulsing / Start Bursting	27
8.10.1	Start Pulsing / Single Pulse	27
8.10.2	Start Bursting / Single Burst.....	28
8.10.3	Externally triggered Pulses or Bursts.....	29
8.11	Status Bar Messages	30
8.12	Menus	30
9	DLL	32
10	Operating modes overview	33
10.1	Pulse Types	33
10.2	Free-Running Mode (Pulses not synchronized)	33
10.3	Synchronized Mode (Pulses synchronized with external Event)	34
11	Information on Recycling and Disposal	36
12	Customer service	37
13	Warranty	38

1 Declaration of Conformity

Manufacturer:
Langer EMV-Technik GmbH

Nöthnitzer Hang 31
01728 Bannewitz
Germany



Langer EMV-Technik GmbH herewith declares that the

P202 / P302 L-EFT set, Pulse Injection Langer Pulses 1.5/5 ns and 1.5/20 ns
with **P202, P302, BPS 202** and **FRIWO FW8000/12**

conforms with the following relevant regulations:

- EMC Directive 2014/30/EU
- Low-Voltage Directive 2014/35/EU
- Restriction of certain Hazardous Substances 2011/65/EU

The following applicable standards were used to implement the requirements specified by the a
forementioned directives:

- DIN EN IEC 61000-6-1:2019-11 (EMC immunity)
- DIN EN IEC 61000-6-3:2022-06 (EMC emission)
- DIN EN 61010-1:2020-03 (Safety)
- DIN EN IEC 63000:2019-05 (Restriction of hazardous substances)

Name of the person authorized to compile the technical

Katja Langer

Bannewitz, 2025-10-08

Signature:

A handwritten signature in black ink, appearing to be 'K. Langer', written over a horizontal line.

K. Langer, Managing Director

2 General Information

2.1 Storage of the User Manual

This user manual enables the safe and efficient use of the P202 / P302 L-EFT set. It must be kept close at hand and accessible to the use.

2.2 Reading and Understanding the User Manual

Read the user manual carefully, observe the safety information (Chapter **Fehler! Verweisquelle konnte nicht gefunden werden.**) and follow the instructions given in this manual before putting the device into service.

2.3 Local Safety and Accident Prevention Regulations

The local accident prevention and general safety regulations also apply to ensure that the P202 / P302 L-EFT set is used for its intended purpose.

2.4 Images

Figures and images have been included in this user manual to assist the reader's understanding but may differ from the device's actual version.

2.5 Limitation of Liability

In the following cases, Langer EMV-Technik GmbH can assume no liability for damage to property and personal injury if:

- The information given in this user manual has not been observed.
- P202 / P302 L-EFT set was operated by staff not qualified in the field of EMC.
- P202 / P302 L-EFT set was subjected to unauthorized modifications or technical changes.
- P202 / P302 L-EFT set was not used according to its intended purpose.
- Spare parts or accessories were used that had not been approved by Langer EMV-Technik GmbH.

The actual scope of delivery may deviate from the illustrations and texts in this user manual due to the customization of orders or due to technical changes and innovations.

2.6 Errors and Omissions



The information in this manual has been carefully checked and is believed to be accurate; however, the Langer EMV-Technik GmbH assumes no responsibility for any clerical, typographical, or proofreading errors, or omissions.

2.7 Copyright

The content of this user manual is protected by copyright law and may only be used in connection with the P202 / P302 L-EFT set. This user manual may not be used for any other purpose without the prior written approval of Langer EMV-Technik GmbH.

3 Safety

3.1 Labels and Signs

 <p>General warning sign</p>	 <p>Warning; Electricity</p>	 <p>Prohibition sign; No access for people with active implanted cardiac devices.</p>
<p>Table 1: Safety signs</p>		

Safety instructions in this user manual are marked by symbols (Table 1). Observe the safety precautions and act cautiously to avoid accidents as well as personal and material damages.

3.2 Intended Use

The P202/P302 set is used to determine the pulse immunity of ICs. The devices and accessories in this set may only be used in accordance with the details given in this user manual.

The pulse generators are built according to their specified use therefore they should be used only for the following purposes:

- Injection of pulses into IC pins or balls with P202 or P302 powered by BPS 202.
- Control of the P202 and P302 via BPS 202-Client or DLL.
- The P202 / P302 set must be used in conjunction with the ICE1 set from Langer EMV-Technik GmbH.

Any use beyond these specifications is considered contrary to the intended use.

3.3 Reasonably foreseeable Misuse

	<p>Danger resulting from misuse!</p> <p>Misuse of the P202 / P302 set can lead to dangerous situations!</p>
<p>Warning!</p>	

Incorrect applications of the sets include:

- Use of the product outside of the given specifications.
- Modification or changes to the product without the consent of Langer EMV Technik GmbH.
- Operation of the product with a technical defect.

3.4 Staff Requisition

Only qualified staff with training, knowledge, and experience in the field of EMC is allowed to operate the P202 / P302 set.

Persons whose ability to perform is influenced or impaired by alcohol, drugs, or pharmaceuticals, are not allowed to operate the P202 / P302 set.

Certain functions may only be carried out by qualified personnel of Langer EMV-Technik GmbH.

3.5 Safety Instructions

	<p>Danger resulting from electricity!</p> <p>Risk of injury by electrocution! Risk of burns due to heat!</p>
<p>Warning; Electricity!</p>	

RF currents can cause irreversible damage to the body, therefore the following safety instructions have to be observed.

- All cable connections must be closed before operating the P202 / P302 set.
- Do not touch the probe tip of the P202 / P302 set when it is in operation.
- If any insulation is damaged, the power supply must be disconnected immediately.
- Damaged parts must be replaced with undamaged parts before operation. Contact Langer EMV-Technik GmbH to obtain a replacement.
- Protect live parts from moisture to avoid short circuits.
- Never leave a Langer EMV-Technik GmbH product unattended while it is in operation.

	<p>Danger resulting from electro-magnetic fields!</p> <p>Risk of affecting a cardiac device!</p>
<p>Prohibition; No access for people with active implanted cardiac devices</p>	

Electromagnetic near fields are generated at the probe due to its function. Therefore, persons with a cardiac device, such as a pacemaker, must not work on or approach the P512 Set during operation.

4 Scope of delivery

Item	Designation	Type	Qty.
1	Pulse current generator Langer Pulse 1.5/5 ns	P202 L-EFT	1
2	Pulse voltage generator 500 V Langer Pulse 1.5/20 ns	P302 L-EFT	1
3	Burst power station	BPS 202	1
4	Control cable, Fischer-Fischer	SK FI-FI 7P 1 m	1
5	USB cable type A-B	USB-AB	1
6	Power supply	12 V / 1 A	1
7	Software	BSP 202-Client, DLL	1
8	User manual		1
9	Case		1

Important: The scope of delivery may deviate depending on the respective order.



Figure 1: P202 / P302 set system case

5 Technical Parameters

5.1 P202

Internal resistance	$\approx 1 \Omega$
Coupling capacity	1.2 μF
Pulse parameter	
Shape	1.5 / 5 ns
Frequency	0.1 Hz – 10 kHz
Voltage	$\pm (0.4 - 40) \text{ V}$
Inductance	$\approx 2 \text{ nH}$
Sizes (L x W x H)	(78 x 35 x 31) mm
Table 2: Technical parameters P202	

5.2 P302

Internal resistance	$\approx 150 \Omega$
Coupling capacity	20 pF
Pulse parameter	
Shape	1.5 / 20 ns
Frequency	0.1 Hz – 10 kHz
Voltage	$\pm (5 - 500) \text{ V}$
Inductance	50 nH
Sizes (L x W x H)	(78 x 35 x 31) mm
Table 3: Technical parameters P302	

5.3 BPS 202

Output voltage	$\pm (5 \dots 500) \text{ V}$
External trigger input	TTL / BNC
Trigger-pulse delay (bypass mode – delay line)	
Min. trigger-pulse delay (typ.)	30 ns
Max. jitter (typ.)	$\pm 1 \text{ ns}$
Trigger-pulse delay (timer mode)	
Min. trigger-pulse delay (typ.)	130 ns
Max. trigger-pulse delay (typ.)	100 ms
Max. jitter (typ.)	$\pm 15 \text{ ns}$
Trigger delay, min. increment	10 ns
Supply voltage	12 V / 1 A DC
Weight	300 g
Sizes (L x W x H)	(175 x 122 x 51) mm
Software	BPS 202-Client / DLL (32 Bit / 64 Bit)
Table 4: Technical parameters BPS 202	

5.4 BPS 202-Client

Operating System	Win 10 / 11
Table 5: Technical parameters BPS 202-Client	

5.5 Operating Requirements

Temperature range	10 – 30°C
Max. humidity	85%
Table 6: Environment	

6 Design and Operating Principle

6.1 Overview

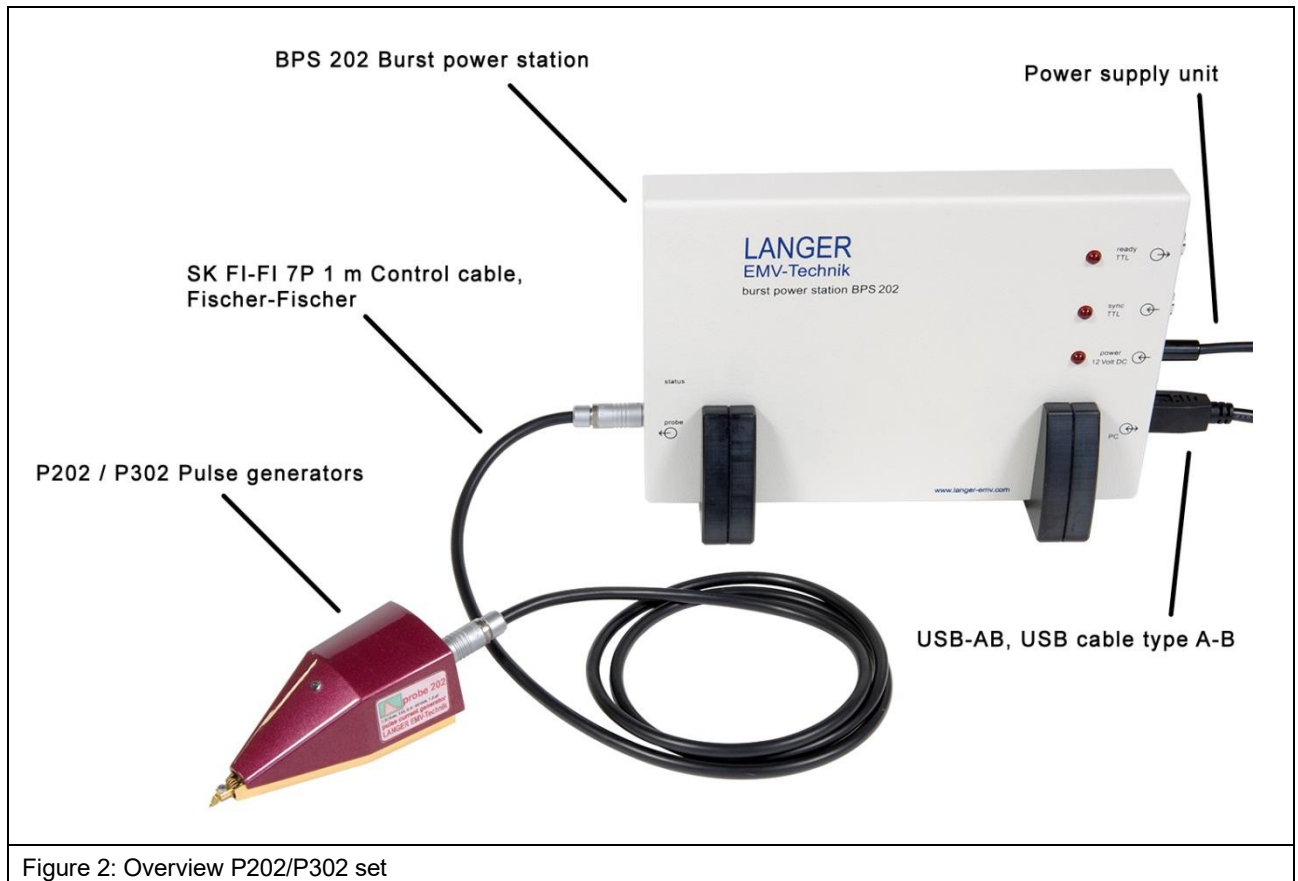

Figure 2: Overview P202/P302 set

Name	Description
P202	Pulse current generator
P302	Pulse voltage generator
BPS 202	Supplies high voltage and control signals to the pulse generators
SK FI-FI 7P 1 m	Connects pulse generators with the BPS 202
USB-AB	Connects the BPS 202 with a PC
Power supply unit	12 V / 1 A, used to power the BPS 202
BPS 202-Client / DLL	PC software to control pulse generators

Table 7: Description of P202 / P302 set

6.2 Additional Equipment

This additional equipment is needed to operate the P202 / P302 set.

- Windows PC
- ICE1 set¹

¹ Product of Langer EMV-Technik GmbH

6.3 Description

The pulse generators P202 and P302 are used for pulse injection into IC pins and balls. The generators are supplied and controlled by the BPS 202 burst power station.

The P202 / P302 set has to be used in conjunction with the ICE1 set².

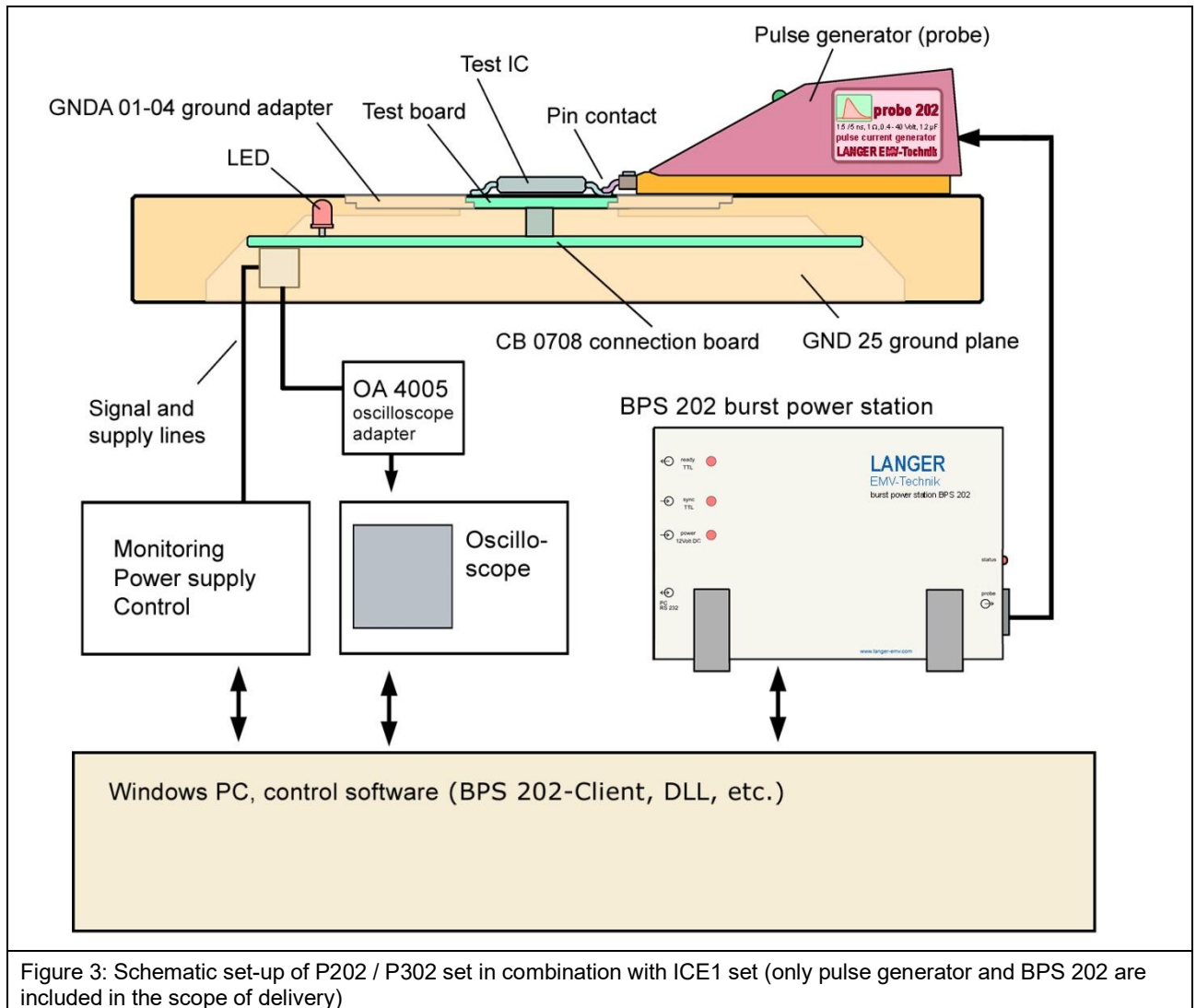

² ICE1 set is not included.

6.4 BPS 202



Figure 4: BPS 202 burst power station

The BPS 202 is used as power supply and control unit for the pulse generators. The control unit is connected to the user's Windows PC. The provided USB stick includes the BPS 202-Client software and a DLL for implementing automated systems.

The sync TTL input allows for the synchronization of the pulse generation with external events, e.g. operation sequences of ICs.

Features are:

- Adjustment of the pulse frequency and pulse voltage
- Single pulse or pulse sequence
- External triggering
- Adjustable trigger delay
- Synchronization output

6.4.1 Connections and LEDs of BPS 202



Figure 5: Designation of connections and LEDs of BPS 202

Table 8 shows all connections of the BPS 202.

Connection	Description
Control Cable Socket	High-voltage power supply and pulse generator communication
Ready TTL Output / BNC	Used for external triggering, high state indicates that the BPS 202 has finished building up high voltage and is ready to start the pulse
Sync TTL Input / BNC	Used for external triggering, the trigger pulse is sent from an external source to the BPS 202 to start the disturbance pulse. The BPS 202 reacts on the rising or falling edge (adjustable in BPS 202-Client or DLL).
Power Supply	Power input for BPS 202
USB-B Port	To connect BPS 202 to a PC via USB A-B cable

Table 8: BPS 202 LEDs and Interface

Table 9 shows the states and descriptions of the LEDs of the BPS 202.







LED	State	Description
Status		10 Hz Fault: Probe is not connected or is incorrectly connected
		2 Hz Generator is ready
		2 Hz Pulse operation
Ready TTL Sync TTL		2 Hz Bootloader state (during firmware update)
Ready TTL		- External trigger is ready to initiate (start pulse)
Sync TTL		- External trigger pulse received
12 V Power		- BPS 202 is powered

Table 9: BPS 202 states (Indicator LEDs)

Figure 6 shows the block diagram of the BPS 202. The internal logic is controlled by the BPS 202-Client or the DLL.

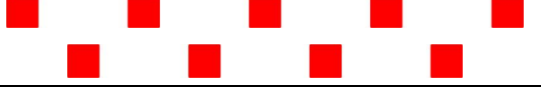
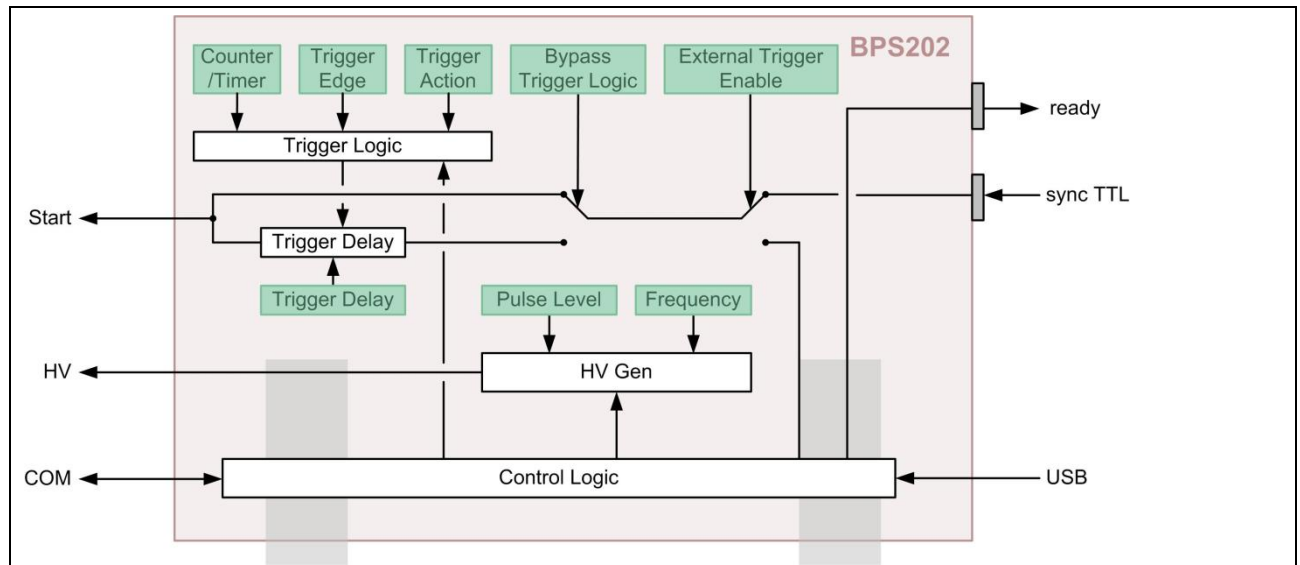

Figure 6: Block diagram of the BPS 202

6.5 Pulse Generators

6.5.1 Overview

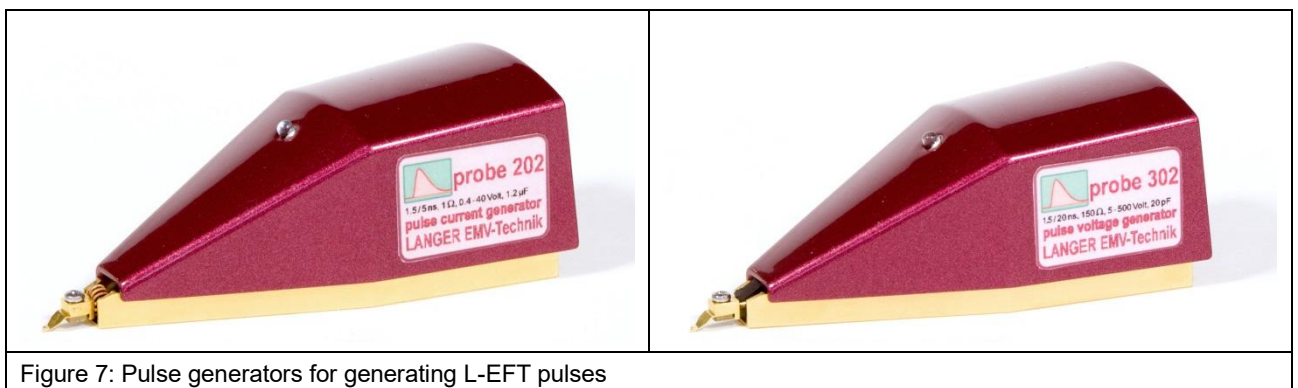

Figure 7: Pulse generators for generating L-EFT pulses

The pulse generators inject disturbance pulses into ICs. These pulses are L-EFT pulses with a defined rise time and pulse width (see Table , Table).

A successful contact between the generator tip and an IC pin or ball can be determined with the help of the internal probe tip contact detection. This is recognizable by the state of the generator LED (Figure 8, Table 10).

The connection detection can be enabled and disabled within the BPS 202-Client or by the corresponding DLL function call.

6.5.2 Status and Generator LED

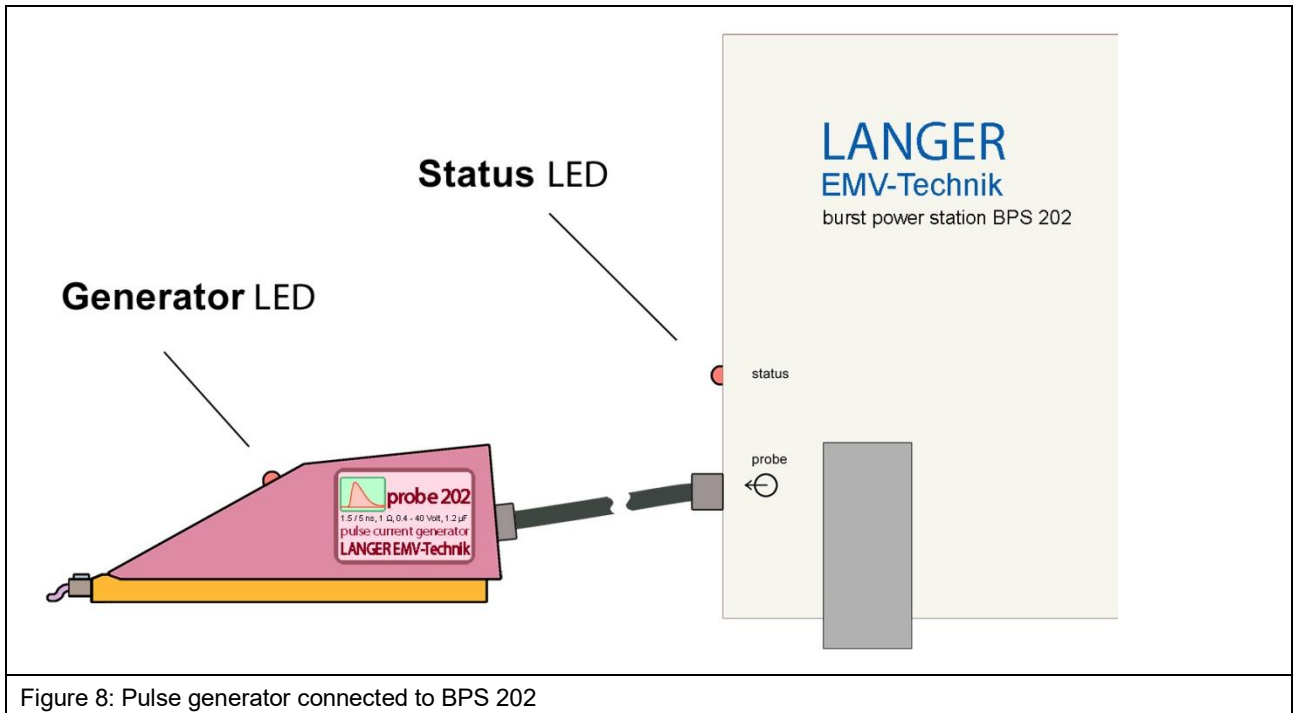

Figure 8: Pulse generator connected to BPS 202

The current operational state of the connected pulse generator is indicated by the multi-color generator LED. The possible states are listed in Table 10.





State		Description
	Strobe	System start
	Continuous	Generator is ready
	2 Hz	Pulse operation
	2 Hz	Bootloader state (during firmware update)
	Continuous	Detected connection at the generator tip

Table 10: Operational states of the pulse generators LED.

6.5.3 P202 Pulse Current Generator

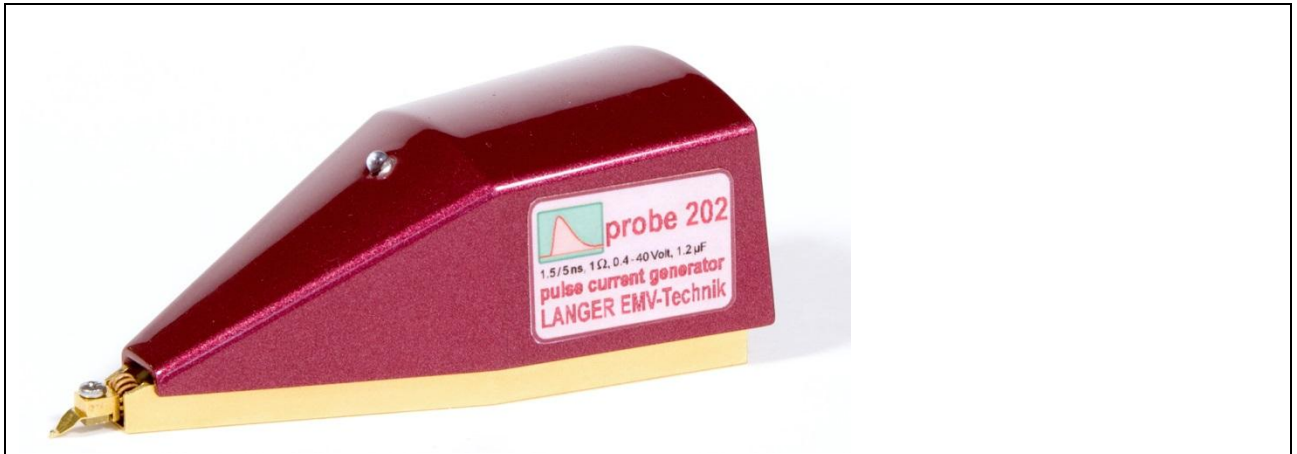

Figure 9: P202 pulse current generator

The P202 has a tip for contacting an IC pin or ball. The pulse current generator is powered with the BPS 202 via SK FI-FI 7P 1 m control cable. The control cable is plugged into the socket on the back side of the generator. The GND contact area on the bottom is magnetic and allows for quick and easy repositioning and prevents the generator from skidding on the GND 25³ ground plane.

The P202 pulse current generator is used for the conductive coupling of disturbance pulses into test ICs. During tests according to the standards IEC 61000-4-2 / ICE 61000-4-4 reduced disturbance pulses could reach IC pins. These pulses are simulated by the P202 generator.

When a magnetic disturbance field couples into a low impedance loop connected to a pin of the test IC, a disturbance voltage will be induced. This voltage drives a disturbance current pulse into the IC pin and can lead to functional interferences. This coupling mechanism can be simulated by the low-impedance P202 pulse current generator ($\approx 1 \Omega$). The pulse voltage is adjustable within the range of $\pm (0.4 - 40) \text{ V}$.

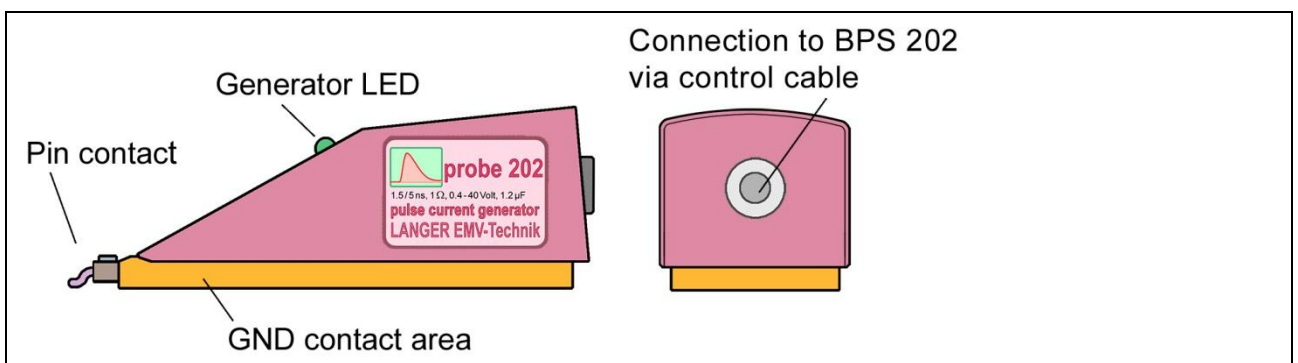

Figure 10: Schematic view from the side and back of P202

³ GND 25 is not included in P202 / P302 set. GND 25 is Included in ICE1 set.

Figure 11 shows the equivalent circuit of the P202 pulse generator at an IC pin.

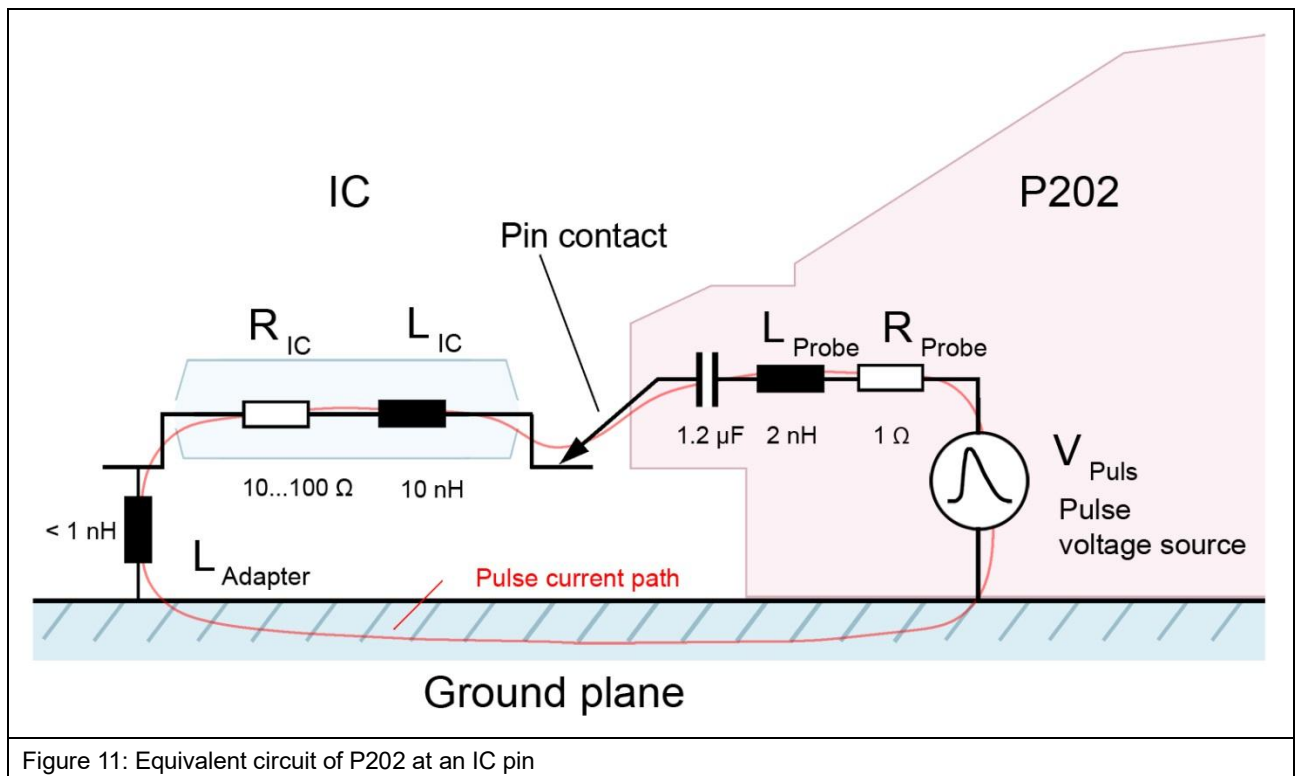

Figure 11: Equivalent circuit of P202 at an IC pin

6.5.4 P302 Pulse Voltage Generator



Figure 12: P302 pulse voltage generator

The P302 has a tip for contacting an IC pin or ball. The pulse voltage generator is powered with the BPS 202 via SK FI-FI 7P 1 m control cable. The control cable is plugged into the socket on the back side of the generator. The GND contact area on the bottom is magnetic and allows for quick and easy repositioning and prevents the generator from skidding on the GND 25⁴ ground plane.

The P302 pulse voltage generator is used for the conductive coupling of disturbance pulses into test ICs. During tests according to the standards IEC 61000-4-2 / ICE 61000-4-4 reduced disturbance pulses could reach IC pins. These pulses are simulated by the P302 generator.

When an electrical disturbance field couples into the traces of a test IC, the disturbance voltage of the connected impedances will drop. This voltage drop occurring at the IC pins can lead to functional interferences. This coupling mechanism can be simulated by the high-impedance P302 pulse voltage generator ($\approx 150 \Omega$). The pulse voltage is adjustable within the range of $\pm (5 - 500) \text{ V}$.

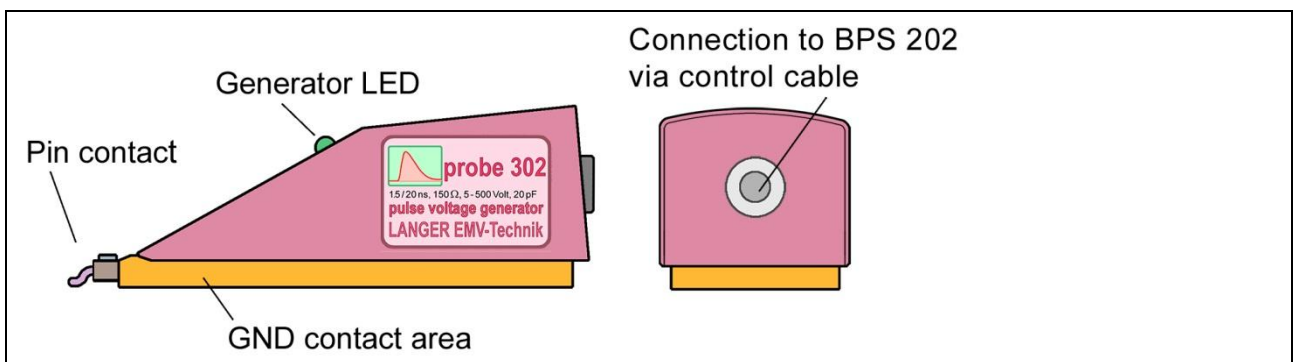

Figure 13: Schematic view from the side and back of P302

⁴ GND 25 is not included in P202 / P302 set. GND 25 is Included in ICE1 set.

Figure 14 shows the equivalent circuit of the P302 pulse generator at an IC pin.

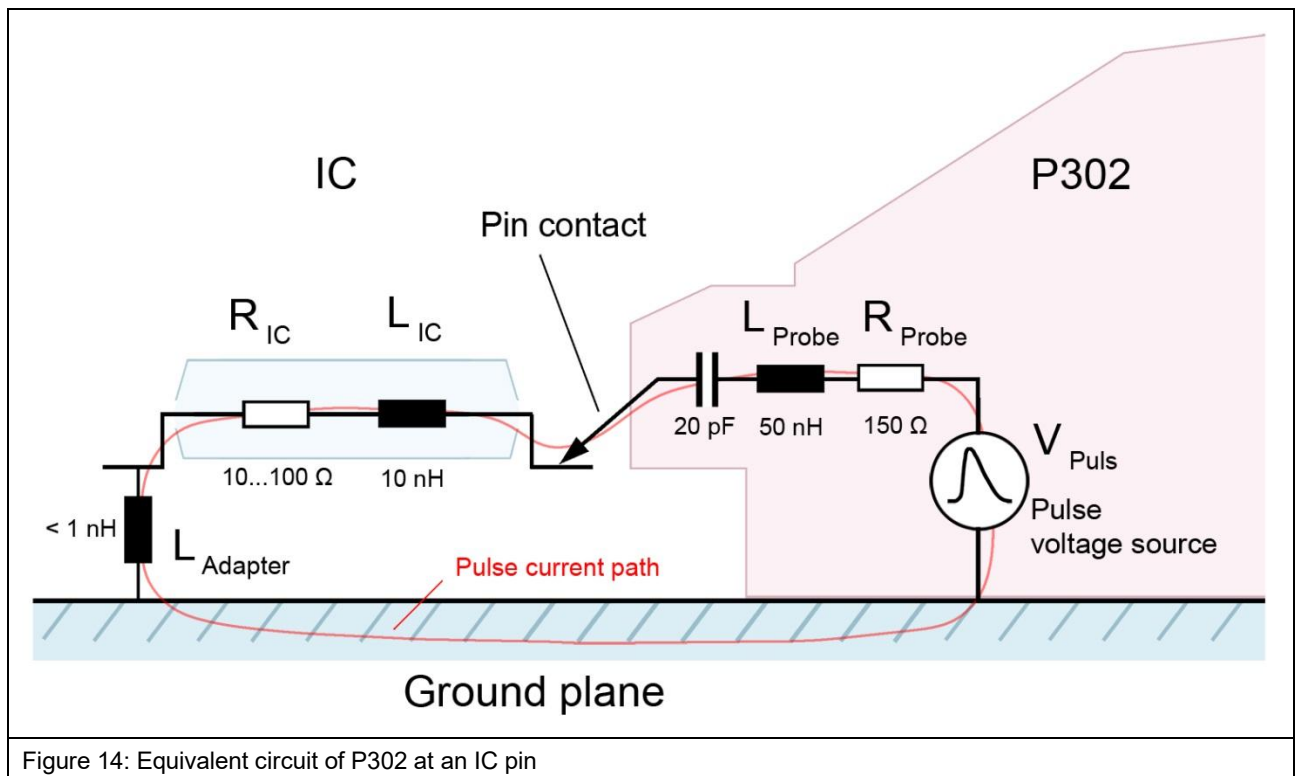

Figure 14: Equivalent circuit of P302 at an IC pin

7 Set-up and Commissioning

7.1 Description

The P202 / P302 set requires the ICE1⁵ set to operate as intended.

The GND 25⁶ ground plane holds the test board with the test IC. The test board is connected to the CB 0708⁷ connection board or an individually constructed electronic device. The connection board or electronic device allows for monitoring and controlling of the test IC and supplying power to it.

The pulse generator has to be selected according to the specific application. The BPS 202 is connected to the pulse generator. The pulse generator is placed on the GND 25 and the contact between the generator tip and the respective pin has to be established. The functions of the generator are controlled via BPS 202-Client software.

7.2 Quick Start

7.2.1 ICE1 set

1. Install Connection Board Control software onto PC
2. Install prepared CB 0708 connection board into GND 25
3. Insert the prepared test board with the test IC into the GNDA ground adapter
4. Fasten the GNDA ground adapter to the GND 25 with the four provided screws
5. Connect power supply to CB 0708
6. Connect measurement devices to CB 0708
7. Connect CB 0708 to PC
8. Start the Connection Board Control software

7.2.2 P202 / P302 set

1. Install BPS 202-Client onto PC
2. Connect the pulse generator with the BPS 202 via the provided control cable
3. Connect the power supply (plugged into the socket) to the BPS 202:
 - the generator LED lights up green
 - the status LED of the BPS 202 flashes with 2 Hz
4. Connect the BPS 202 to the PC via the provided USB cable
5. Start the BPS 202-Client Software

⁵ ICE1 set is not included.

⁶ GND 25 is not included in the P202 / P302 set. GND 25 is included in the ICE1 set.

⁷ CB 0708 is not included in the P202 / P302 set. CB 0708 is included in the ICE1 set.

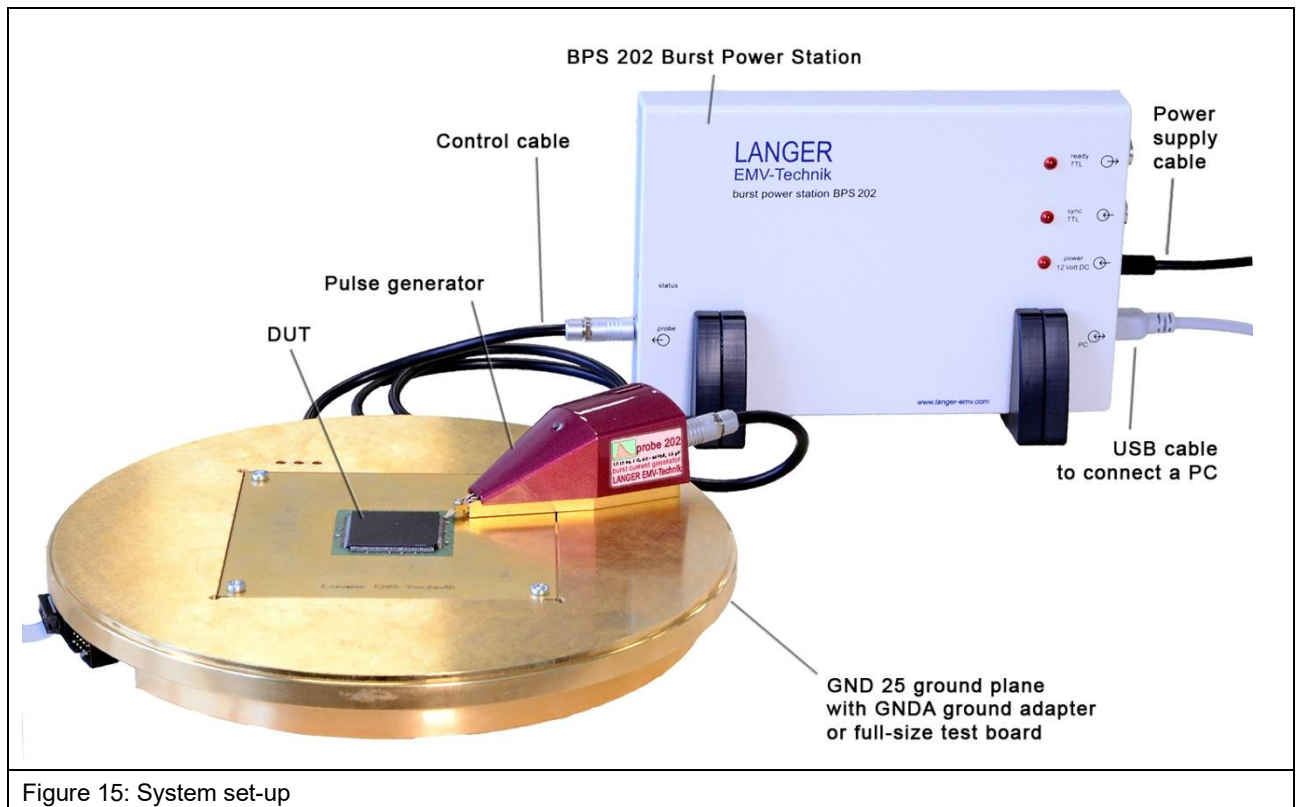

Figure 15: System set-up

8 BPS 202-Client Software

8.1 Requirements

- Windows PC with Win XP SP3 or higher
- administrator rights

8.2 Installation

Important: You need administrator rights to install the device driver on the PC.

The enclosed installation media contains:

- BPS 202-Client software and DLL
- user manual
- device driver

Instructions:

1. Double click the installer file BPS 202-Client-*.exe on the installation media.
2. Follow the instructions during the installation.
3. Proceed with the device driver installation which follows automatically.

After installing the BPS 202-client and the device driver connect the BPS 202 and pulse generator as described in Section 7.2.2.

8.3 General Notes

The BPS 202-Client software contains all control elements needed to operate the BPS 202 and its pulse generators in all its operating modes.

Important: The BPS 202-Client automatically detects the connected pulse generator and displays only relevant settings and values.

The Graphical User Interface (GUI) consists of:

- Pulse configuration
- Burst configuration (*Burst Mode only*)
- Trigger Control
- Start / Stop
- Status bar

Settings are only possible if a valid BPS 202 and a valid pulse generator are detected by the software. This is displayed in the status bar (see Section 8.11).

After launching the software, Pulse Mode is always preselected in the main dialog, see Figure 16.

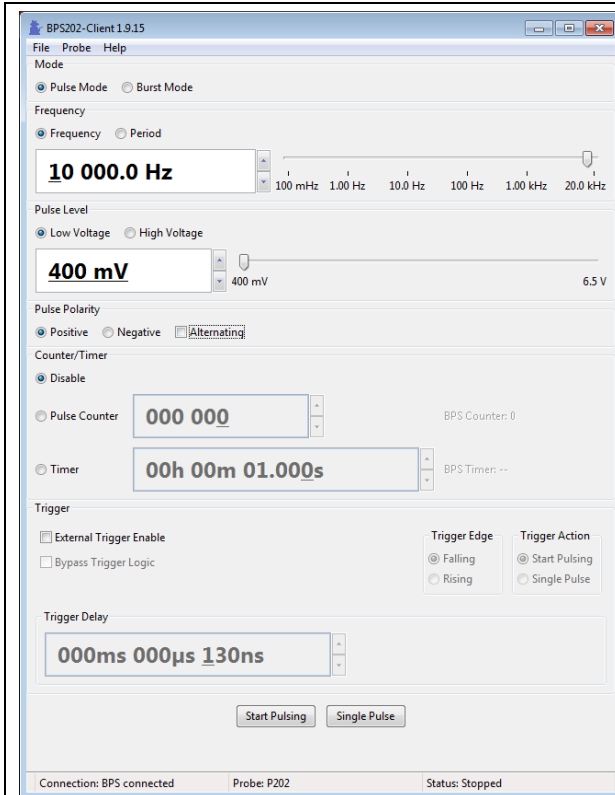

Figure 16: Main Dialog Pulse Mode

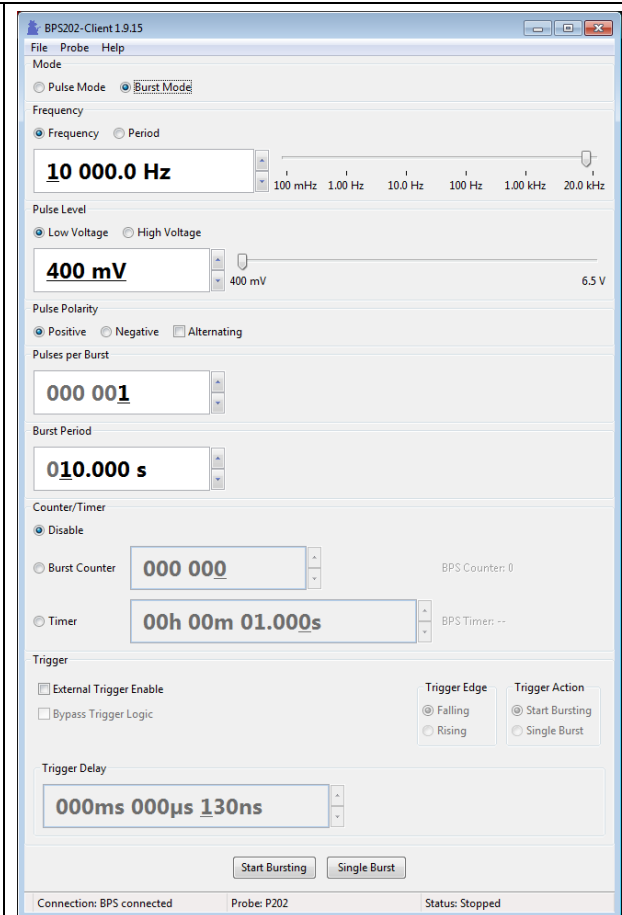

Figure 17: Main Dialog Burst Mode

8.4 Setting of the Operating Mode

The operating modes Pulse Mode and Burst Mode can be chosen within the Mode section by clicking the respective radio button. The main dialog changes according to the chosen mode (see Figure 16 and Figure 17).

- a. Pulse Mode: creates several pulses that are equidistant in time
- b. Burst Mode: creates packets of pulses that are equidistant in time

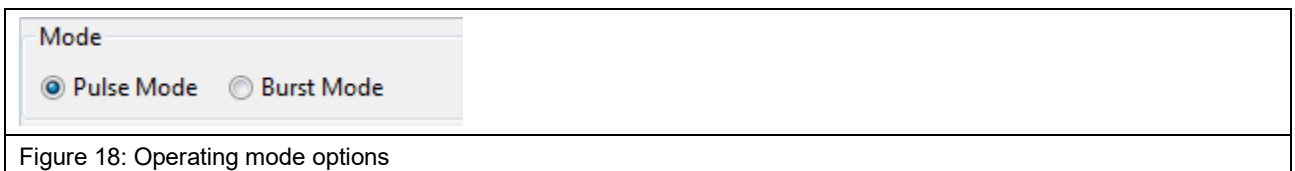

Figure 18: Operating mode options

8.5 Pulse Configuration

8.5.1 Setting of the Pulse Frequency or the Pulse Period

The Pulse Frequency can be set in the Frequency section of the GUI (Figure 19) in the range from 100 mHz to 10 kHz (depending on the used generator).

The Pulse Period can be set in a range from 50 μ s to 10 s. Pulse Frequency and Pulse Period can be selected by clicking the corresponding radio button.



Figure 19: Setting of the Pulse Frequency

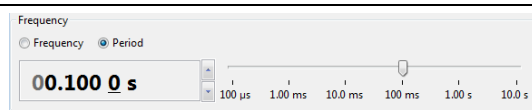

Figure 20: Setting of the Pulse Period

8.5.2 Setting of the Pulse Level

The voltage amplitude of the pulses can be set in the Pulse Level section of the GUI (Figure 21). The pulse level slider allows for a rough adjustment and the spin buttons allow for a fine grain adjustment. Switching between two different voltage ranges with the options Low Voltage and High Voltage is possible. The setting of the Pulse Level is possible in Pulse Mode or Burst Mode and if the BPS 202 has not been started via Start Pulsing button or Start Bursting button.



Figure 21: Setting of the Pulse Level with Low Voltage option selected

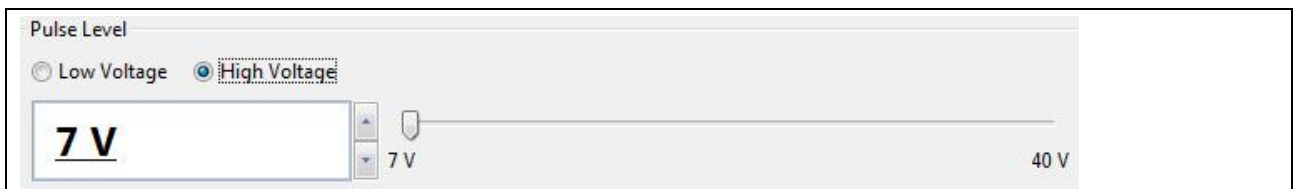

Figure 22: Setting of the Pulse Level with High Voltage option selected

8.6 Setting of the Pulse Polarity

The polarity of the created pulses can be set in the Pulse Polarity section of the GUI. The available options are:

- Positive (+)
- Negative (-)

Important: Alternating of the polarity isn't available with the P202 and P302 pulse generators.

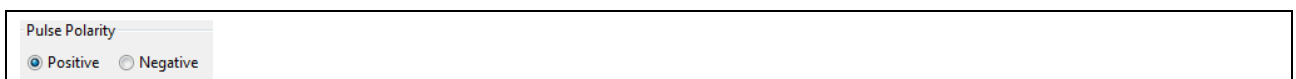

Figure 23: Setting of the Pulse Polarity

8.7 Burst Configuration

When the Burst Mode is chosen, the burst configuration section is displayed. In this operating mode, the Burst Period and the number of Pulses per Burst are additional parameters which have to be defined.

8.7.1 Setting the Number of Pulses per Burst

In the Pulses per Burst section the number of pulses per burst packet can be set (Figure 24).



Figure 24: Setting of the number of Pulses per Burst packet

8.7.2 Setting of the Burst Period

In the section Burst Period the time between two consecutive burst packets can be set. The minimal value of the burst period is derived from the number of pulses in each burst packet and the value of the set pulse frequency.

$$BurstPeriod_{Min} = \frac{1}{Frequency} * Pulse_per_Burst \quad \text{Eq. 1}$$

$$BurstPeriod_{Min} = Period * Pulse_per_Burst \quad \text{Eq. 2}$$



Figure 25: Burst Period is the time between two consecutive burst packets

8.8 Setting of a Defined Pulse Counter or Timer

In the Counter/Timer section of the GUI the Pulse Counter, Burst Counter, or the Timer can be set.

The following three options are available:

1. Disable: No counter or timer is set → Start Pulsing/Bursting leads to continuous pulses
2. Pulse Counter (Pulse Mode): Start Pulsing generates the selected number of pulses
3. Burst Counter (Burst Mode): Start Bursting generates the selected number of pulses
4. Timer: Start Pulsing/Bursting will run the selected function for the length of the timer

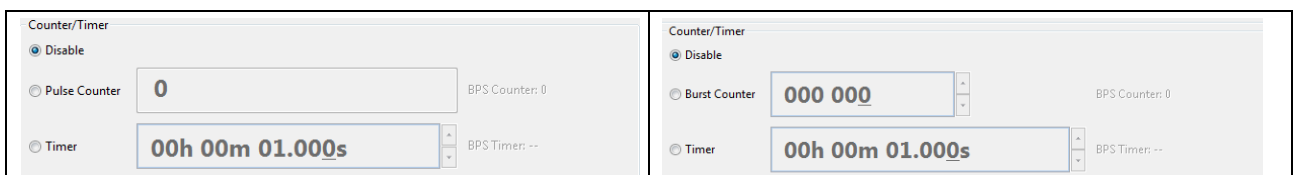

Figure 26: Setting of a defined Pulse counter, Burst Counter or a Timer

8.9 Setting of the External Trigger

The control of the external trigger is done in the Trigger section of the GUI.

By enabling the box External Trigger Enable, the following options will be available:

- Trigger edge:
 1. Falling: Trigger activated at HIGH – LOW transition
 2. Rising: Trigger activated at LOW – HIGH transition
- Trigger Action in Pulse Mode:
 1. Start Pulsing: generates test pulses with the set pulse parameters
 2. Single Pulse: generates one test pulse with the set pulse parameters
- Trigger action in Burst Mode:
 1. Start Bursting: generates burst packets with the set burst parameters
 2. Single Burst: generates one burst packet with the set burst parameters
- The Trigger Delay can be set in steps of 10 ns (see Section 10.3).



Figure 27: GUI section Trigger for operating mode pulse mode

- Bypass Trigger Logic:
 1. With this option you bypass the trigger logic and the smallest trigger delay of the system is used.

8.10 Start Pulsing / Start Bursting

8.10.1 Start Pulsing / Single Pulse

Single Pulse

By pressing the Single Pulse button (Figure 28) the BPS 202 will generate a single pulse with the defined Pulse Level and Polarity. The Status LED of the BPS 202 and the Generator LED of the connected probe will blink one time, as described in Section 6.4.1.

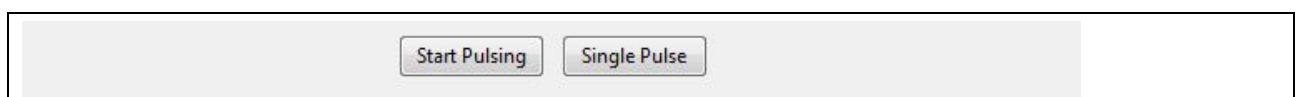

Figure 28: Start Pulsing and Single Pulse buttons

Continuous Pulses

When the Start Pulsing button (Figure 28) is pressed, the BPS 202 will generate continuous pulses with the defined pulse parameters. Additionally the LED on the connected generator and the Status LED on the BPS 202 will blink continuously, the software's status will display "Status: running" (see Section 8.11), and the Start Pulsing button changes to Stop Pulsing. The Pulse Frequency and Voltage can be changed at any time. The continuous pulses can be stopped at any time by pressing the Stop Pulsing button.

Depending on the Counter/Timer settings, the pulses generated by the BPS 202 can be defined by time (also unlimited) or number.

The pulses or the time remaining is displayed next to the set value and is updated continuously.



Figure 29: BPS Counter in Counter/Timer section



Figure 30: BPS Timer in Counter/Timer section

8.10.2 Start Bursting / Single Burst

Single Burst

By pressing the button Single Burst (Figure 31) the BPS 202 will generate a single burst packet with the defined burst parameters. Additionally, the Status LED and the Generator LED will blink as described in Section 6.5.1.

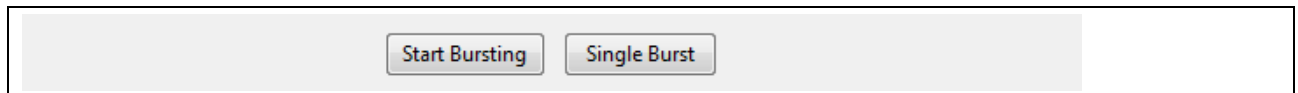

Figure 31: Start Bursting and Single Burst buttons

Continuous Burst

When the Start Bursting button (Figure 31) is pressed, the BPS 202 will generate continuous bursts with the defined burst parameters. Additionally the LED on the generator and the Status LED on the BPS 202 will blink continuously, the software's status will display "Status: running" (see Section 8.11) and the Start Bursting button changes to Stop Bursting. The burst frequency and voltage can be changed at any time. The continuously generated bursts can be stopped at any time by pressing the Stop Bursting button.

Depending on the Counter/Timer settings, the bursts generated by the BPS 202 can be defined by time (also unlimited) or number.

The bursts or the remaining time is displayed next to the set value and is updated continuously.

8.10.3 Externally triggered Pulses or Bursts

The generated pulses or bursts can be synchronized with an external event by activating the External Trigger Enable option. When the Start Pulsing or Start Bursting button is pressed,

- the Start Pulsing / Start Bursting button changes to Stop Pulsing or Stop Bursting respectively and will stop the generation of pulses or bursts when pressed,
- the ready TTL LED of the BPS 202 lights up,
- the BPS 202 waits for a trigger event at its sync TTL input,
- Status bar of the BPS 202-Client displays the status message "Status: Waiting for Trigger".

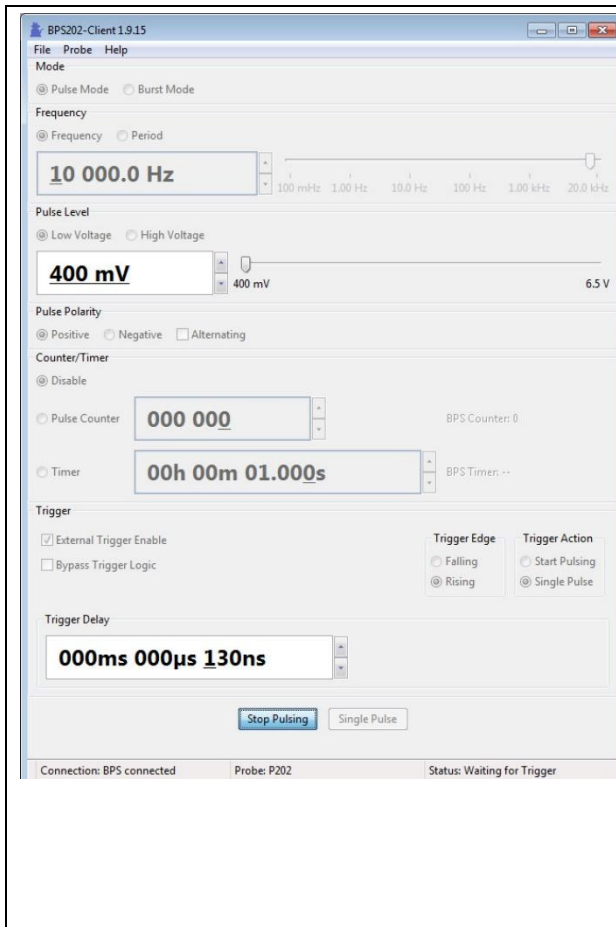

Figure 32: Trigger for **Pulse Mode**

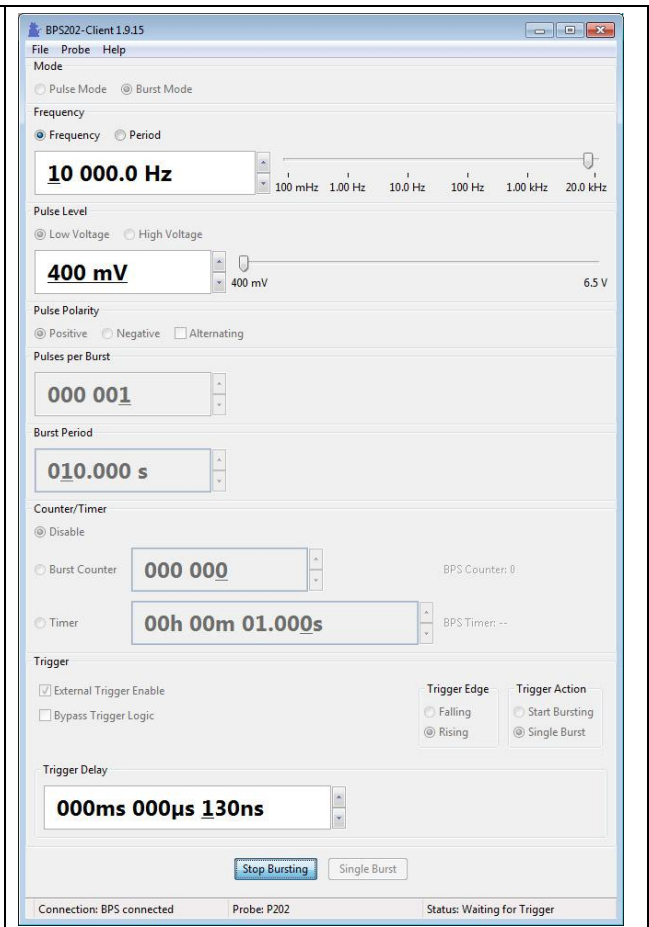

Figure 33: Trigger for **Burst Mode**

The Trigger Edge and the reaction of the BPS 202 to a trigger event can be set in the Trigger section. A trigger event recognized at the input sync TTL of the BPS 202 executes the defined Trigger Action, which is indicated by the blinking Status LED and Generator LED.

By activating the Counter and Start Pulsing options, each trigger event will prompt the defined number of pulses or bursts.

Caution: The minimum delay relates only to the signal propagation delay in the BPS 202. The total delay varies dependent on the attached generator, pulse voltage, and polarity. (see chapter 0)

8.11 Status Bar Messages

The status bar of the BPS202-Client consists of:

1. Status of the BPS 202 USB connection:

- Connection: BPS disconnected
- Connection: BPS connected

2. Status of the automatic generator/probe recognition:

- No Probe detected
- *Probe type* detected

3. Operating mode of the BPS 202:

- Status: stopped – no generation of pulses or bursts
- Status: running – generating pulses or bursts
- Status: Waiting for Trigger – BPS 202 waits for an external trigger event

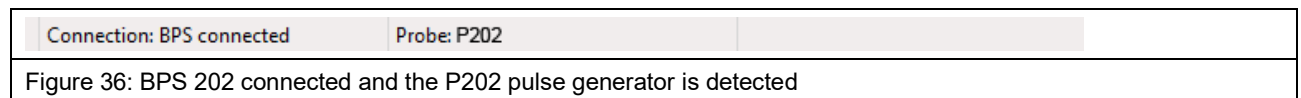
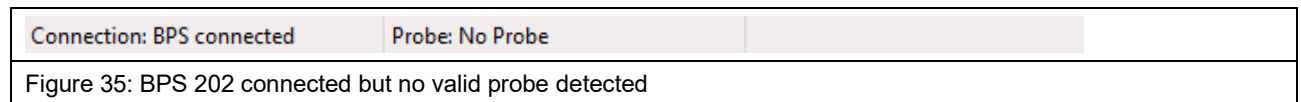
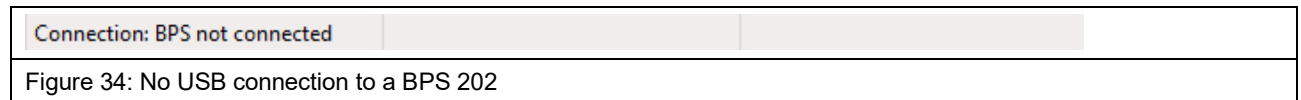

8.12 Menus

File:

- EXIT:Shuts down the BPS202-Client

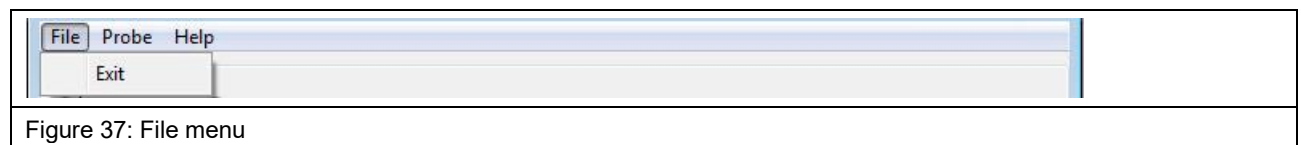

Probe:

- Probe Tip Contact Detection:Activation and deactivation of the contact detection function



Help:

- Hardware Info: Display hardware information about the BPS 202 and its connected generator/probe.
- About: Software information / link to <https://www.langer-emv.com/>
- Manual: Display User Manual
- Update BPS Firmware: Open the BPS 202 firmware update dialog
- Update Probe Firmware: Open the generator/probe firmware update dialog

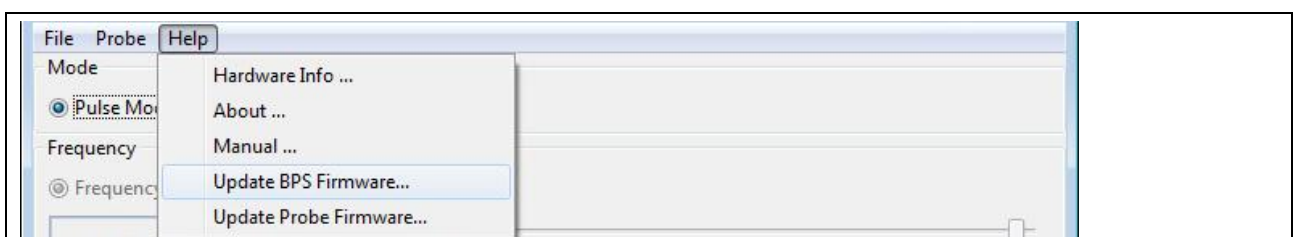

Figure 39: Help menu

9 DLL

The **BPS 202-Client** contains a DLL to control the **BPS 202** by function calls. Depending on your system (32bit or 64bit), the DLL file and the corresponding header file are stored at:

<installation path>\BPS202-Client_ *Version* \dll_Win32 or

<installation path>\BPS202-Client_ *Version* \dll_x64

The **BPS 202 remote control commands** are explained in either the header file or the programming manual “**BPS 202 Programming Manual.pdf**”.

10 Operating modes overview

10.1 Pulse Types

The P202/P302 set can generate the following types of pulses:

- Single pulse (Figure 40)
- Continuous pulse
- Burst packets with a defined number of pulses and burst periods (Figure 41)
- Defined number of pulses or burst packets

The type of pulse sequence is set by the control software BPS 202-Client or the DLL.

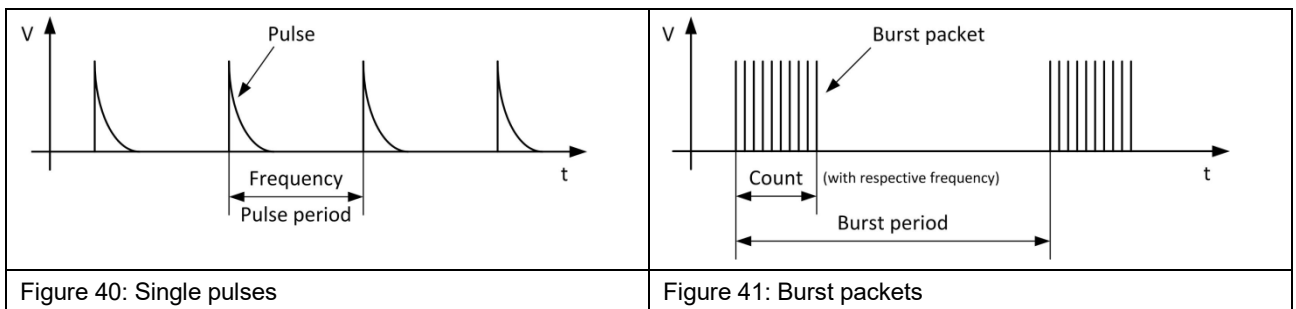

Furthermore, it is possible to synchronize the generated pulses with an external event by using the External Trigger Function.

10.2 Free-Running Mode (Pulses not synchronized)

In free-running mode, the pulse generation is controlled by the BPS 202-Client (see Chapter 8). The pulse generation in this mode cannot be synchronized to external trigger signals.

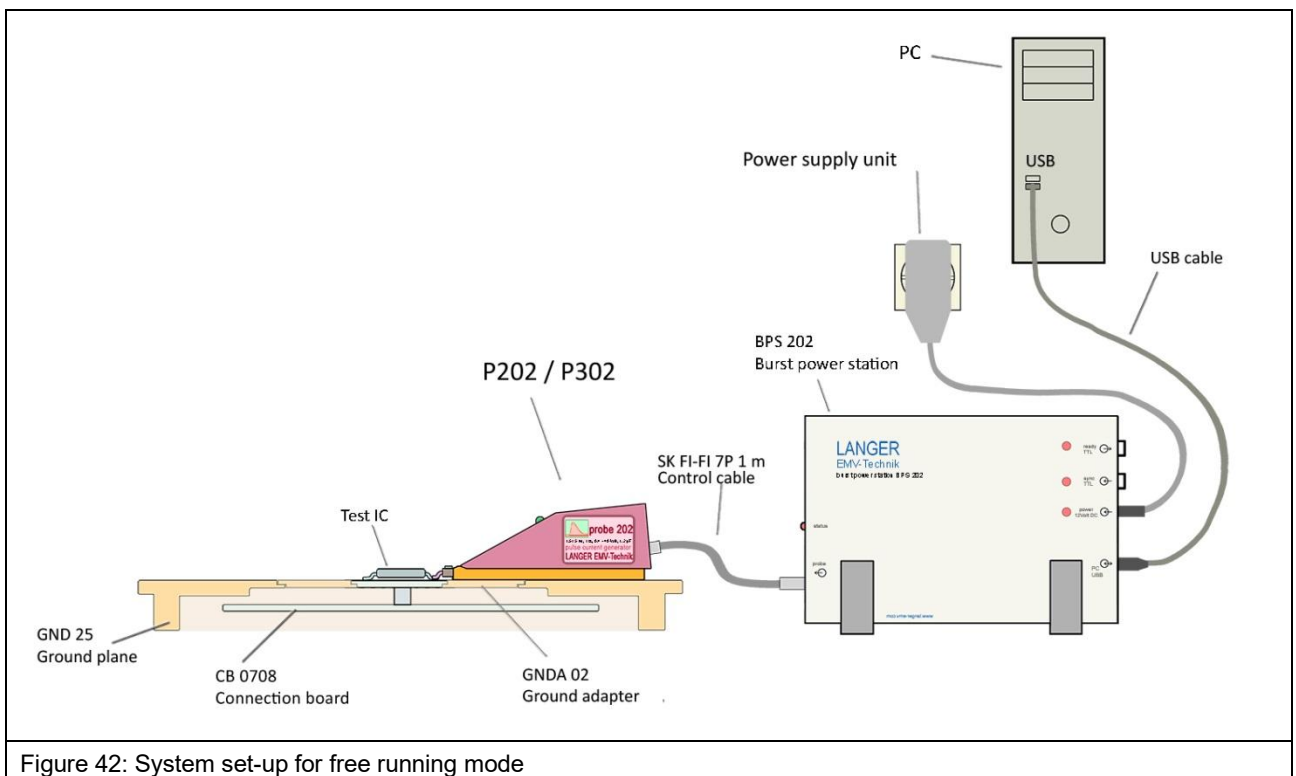

Figure 42: System set-up for free running mode

10.3 Synchronized Mode (Pulses synchronized with external Event)

In the synchronized mode, the pulse can be triggered by an external signal source (Start Logic) e. g. a signal from the test IC (TTL max. 5 V).

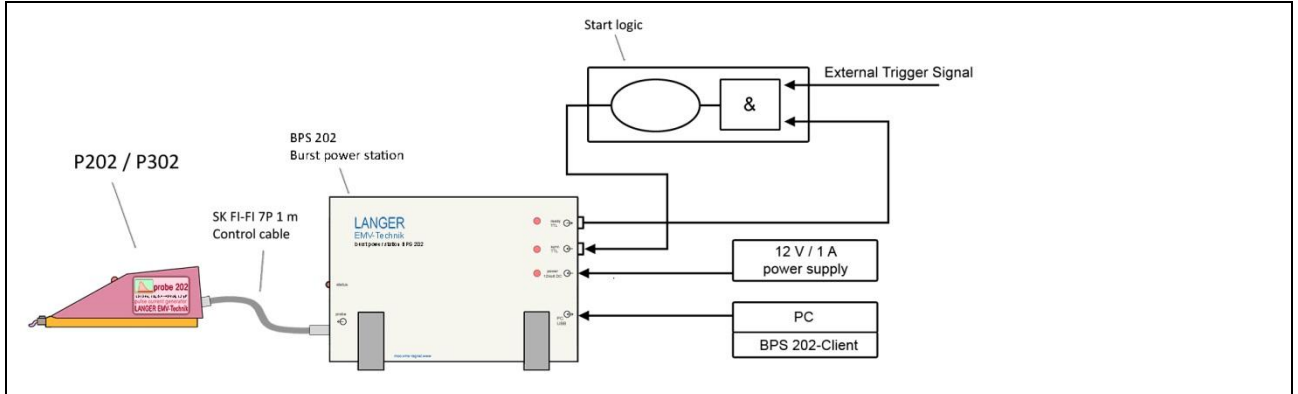

Figure 43 System set-up for external trigger event via BPS 202 sync TTL input

The trigger to pulse delay can be set in the BPS 202-Client (see Figure 6) by using the delay timer in the BPS 202.

The ready TTL output of the BPS 202 signals when the BPS 202 is ready to start a pulse. Figure 44 and Figure 45 show the sequence of control signals when the external trigger mode is used.

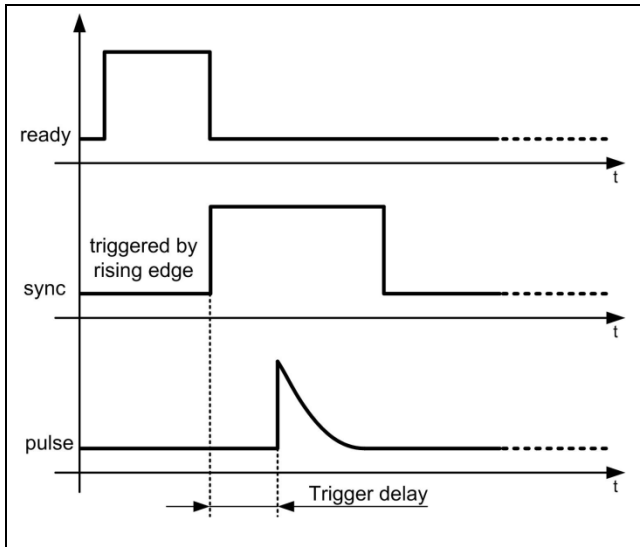

Figure 44: Signal sequence of external trigger mode, trigger on rising edge

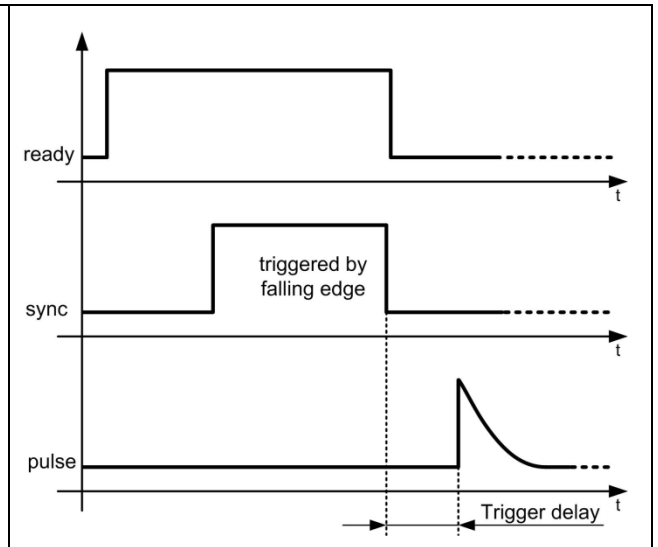

Figure 45: Signal sequence of external trigger mode, trigger on falling edge

Control signals:

Ready: When the ready signal is driven high by the BPS 202, it accepts trigger signals to start pulses.

Sync: The trigger signal for the pulse is fed into this port. The BPS 202 accepts rising or falling edges depending on the setting in the BPS 202-Client software.

Pulse: The generated pulse can be emitted with a variable trigger to pulse delay. For the minimum delay refer to Chapter 0.

Sequence:

- a) external trigger of the BPS 202 is set in the BPS 202-Client software (see Section 8.9),
- b) BPS 202 sets the ready TTL output to high, when the high voltage is built up and a pulse can be triggered,
- c) pulse is emitted on a rising or falling edge at the sync TTL input (Figure 45). This depends on the settings in the BPS 202-Client software (see Section 8.9),
- d) trigger to pulse delay between the trigger signal at the sync TTL input and pulse can be set in the BPS202-Client software.

11 Information on Recycling and Disposal



DE 80567526

In accordance with the WEEE Directive 2012/19/EU (Waste of Electrical and Electronic Equipment), the following must be observed:

At the end of its service life, this product should be taken to a suitable disposal facility for recycling and disposal. Do not dispose of with household waste.

12 Customer service

Please contact us if you have any questions, comments or suggestions.

You can contact us:

Monday – Friday

8:00 Uhr bis 15 Uhr (CET)

Contact us at:

Address:Langer EMV-Technik GmbH

Nöthnitzer Hang 31

01728 Bannewitz

Germany

Internet: <https://www.langer-emv.com/>

E-mail: mail@langer-emv.de

Phone: +49 (0) 351-430093-0

Fax: +49 (0) 351-430093-22

Calibration

We recommend having the product calibrated every two years by the manufacturer Langer EMV-Technik GmbH or by a certified distributor.

13 Warranty

Langer EMV-Technik GmbH shall remedy all defects attributable to material or manufacturing faults within the statutory warranty period by repairing the product or supplying replacement parts.

This guarantee is only granted on condition that:

- the information and instructions in the operating instructions are observed.

The guarantee expires if:

- an unauthorized repair is carried out on the product
- the product is modified
- the product is not used as intended

This document may not be copied, reproduced or processed, duplicated or distributed using electronic systems, either in whole or in part, without the prior written permission of Langer EMV-Technik GmbH. The management of Langer EMV-Technik GmbH accepts no liability for damage resulting from the use of this printed information.