



User Manual

OB 100 set

Opto-Box 100 LIN / CAN



Transmission of LIN signals and high-speed CAN signals via fiber optics

Content:	Page
1. Declaration of Conformity	3
2. General Information	4
2.1. Storing the User Manual	4
2.2. Reading and Understanding the Manual	4
2.3. Local Safety and Accident Prevention Regulations	4
2.4. Images	4
2.5. Limitations of Liability	4
2.6. Errors and Omissions	4
2.7. Copyright	4
3. Scope of Delivery	5
4. Technical Parameters	6
4.1. OB 100 - Opto-Box 100.....	6
4.2. CAN 100 - Optical Fiber Probe	6
4.3. LIN 100 - Optical Fiber Probe	6
5. Safety Instructions	7
6. Information on Recycling and Disposal	8
7. Application	9
8. Design of Opto-Box 100	10
8.1. Mechanical Design.....	10
8.2. GND Connection.....	10
8.3. Voltage Supply.....	11
8.4. Signal Transmission – Electrical Connection	12
8.5. Signal Transmission – Optical Connection.....	13
9. Use of Opto-Box 100	14
9.1. Measurements according to Standards.....	14
9.2. Measurements during Development	15
10. CAN 100 / LIN 100 Sensors	16
10.1. Mechanical Design.....	16
10.2. Optical Connection.....	16
10.3. Electrical Connection	17
11. Warranty	18
12. Customer Service	19

1. Declaration of Conformity

Manufacturer:

Langer EMV-Technik GmbH
Nöthnitzer Hang 31
01728 Bannewitz
GERMANY



Langer EMV-Technik GmbH hereby affirms, that the product specified below

OB 100 set, Opto-Box LIN / CAN
with Opto-Box 100, LIN 100 and CAN 100

agrees with the regulations of EC guidelines:

- EMC Directive 2014/30/EU
- Low Voltage Directive 2014/35/EU
- Restriction of certain Hazardous Substances 2011/65/EU

Applied standards and technical specifications:

- DIN EN IEC 61000-6-1:2019-11 (EMC immunity)
- DIN EN IEC 61000-6-3:2022-06 (EMC emission)
- DIN EN 61010-1:2020-03 (Safety)
- DIN EN IEC 63000:2019-05 (Restriction of hazardous substances)

Person authorized to compile the technical file:

Katja Langer

Bannewitz, 08.09.2025

Signature:

A handwritten signature in blue ink, appearing to be 'KL', written in a cursive style.

Katja Langer, CEO

2. General Information

2.1. Storing the User Manual

This user manual provides the basis for the safe and efficient use of the OB 100 set. It must be kept handy and easily accessible for the user.

2.2. Reading and Understanding the Manual

Read and understand the manual and observe the instructions carefully before using the OB 100 set. Please consult Langer EMV-Technik GmbH if you have any questions or comments.

The user manual must be kept readily available in the immediate vicinity of the product.

2.3. Local Safety and Accident Prevention Regulations

The applicable local general safety and accident prevention regulations must be adhered to.

2.4. Images

Images in this manual facilitate a better understanding but can deviate from the actual execution.

2.5. Limitations of Liability

The Langer EMV-Technik GmbH is not liable for personal injury or damage to material, if

- the instructions in this user manual were not followed,
- the product was used by personnel who are not qualified in the field of EMC and who are not fit to work under the influence of disturbance voltages and electric and magnetic fields,
- the product was not used as intended,
- the product was arbitrarily modified or technically altered,
- spare parts or accessories were used, that were not authorized by Langer EMV-Technik GmbH.

The actual scope of delivery can deviate from the texts and images in this manual in the case of individual adjustments to the order or recent technical changes.

2.6. Errors and Omissions

The information in this user manual has been checked very carefully and found to be correct to the best of our knowledge; however, Langer EMV-Technik GmbH can assume no responsibility for spelling, typographical or proofreading errors.

2.7. Copyright

The content of this user manual is protected by copyright and may only be used in connection with the OB 100 set. This user manual may not be used for other purposes without the prior consent of Langer EMV-Technik GmbH.

3. Scope of Delivery

Item	Designation	Type	Qty.
01	Opto-Box 100	OB 100	2
02	Optical Fiber, Double	LWL double 10 m	1
03	Optical Fiber Probe	LIN 100	1
04	Optical Fiber Probe	CAN 100	1
05	Adapter Socket	3-pole	4
06	Adapter Socket	4-pole	4
07	Enamelled Copper Wire	Wire-CuL	1
08	Power Supply Unit	NT Ex EU	1
09	System Case	(240 x 190 x 55) mm	1
10	Quick Guide		1
11	User Manual		1



4. Technical Parameters

4.1. OB 100 - Opto-Box 100

Sizes (L x W x H)	(132 x 70 x 30) mm
Supply voltage	12 Volt (max. 25 Volt)
Max. current input at 12 V	250 mA when charging rechargeable batteries* 45 mA without charging rechargeable batteries*
Operating time with charged internal battery* (4 x AA* with 2400 mAh)	Up to 1 week depending on operating mode
ESD resistance	+/- 25 kV air and contact discharge
Optical fiber connection	2 x 2.2 mm Ø
Max. optical fiber length	20 m (6 m at 1 Mbit/s CAN)

*Not included in the scope of delivery.

4.2. CAN 100 - Optical Fiber Probe

Sizes (L x W x H) (with connector)	(37 x 12 x 8) mm
Supply voltage	4.5 ... 7.0 Volt
Dielectric strength	+/- 15 V
Current input	Approx. 40 mA (recessive) max. approx. 80 mA (master, receive, dominant)
Max. transmission rate	1 Mbit/s
CAN transceiver	SN65HVD251
Optical fiber connection	2 x 2.2 mm Ø
Max. optical fiber length	10 m (6 m at 1 Mbit/s)

4.3. LIN 100 - Optical Fiber Probe

Sizes (L x W x H) (with connector)	(37 x 12 x 8) mm
Supply voltage	8 ... 15 Volt (as Master) 8 ... 30 Volt (as Slave)
Dielectric strength	+/- 40 V
Current input	approx. 40 mA (recessive) max. approx. 80 mA (master, receive, dominant)
Max. transmission rate	20 kbps
Optical fiber connection	2 x 2.2 mm Ø
Max. optical fiber length	20 m

5. Safety Instructions

When using a product from Langer EMV-Technik GmbH, please observe the following safety instructions to protect yourself against electric shock or the risk of injury.

- Before each use, check externally for damage.
- Damaged or defective devices are not to be used.
- The operating and safety instructions for all devices included in the measurement set-up must be observed.
- The use of the devices under the influence of interference is to be carried out by personnel who are experts in the field of EMC.
- All devices are to be connected or disconnected only when the source of interference is switched off.

6. Information on Recycling and Disposal



Waste Electrical and Electronic Equipment (WEEE) Directive (European Union):

At the end of its useful life, this product should be taken to an appropriate disposal facility for recycling and disposal. Do not dispose of with household waste.



7. Application

An Opto-Box 100 converts electrical CAN or LIN signals into optical signals. The use of two Opto-Box 100 provides a simple possibility to cut an already existing cable connection and to replace a section of the cable - without further configuration effort - with an optical fiber connection.

It is also possible to combine an Opto-Box 100 with a LIN 100 or CAN 100 sensor. The respective sensor should be used directly on the DUT's circuit board. In this way, the CAN or LIN cable can be completely replaced by an optic fiber cable for measurements during development within the test hall/screening cabin, thus achieving a very high interference immunity of the signal connection. At the same time, the interference decoupling from the signal cable is omitted.

Preferably, one Opto-Box 100 is used directly on the higher-level computer and communicates to a second Opto-Box 100 or a LIN or CAN sensor close to the DUT - e.g. inside a measuring cabin.

8. Design of Opto-Box 100

8.1. Mechanical Design

All connection options and switches are shown in Figure 1.

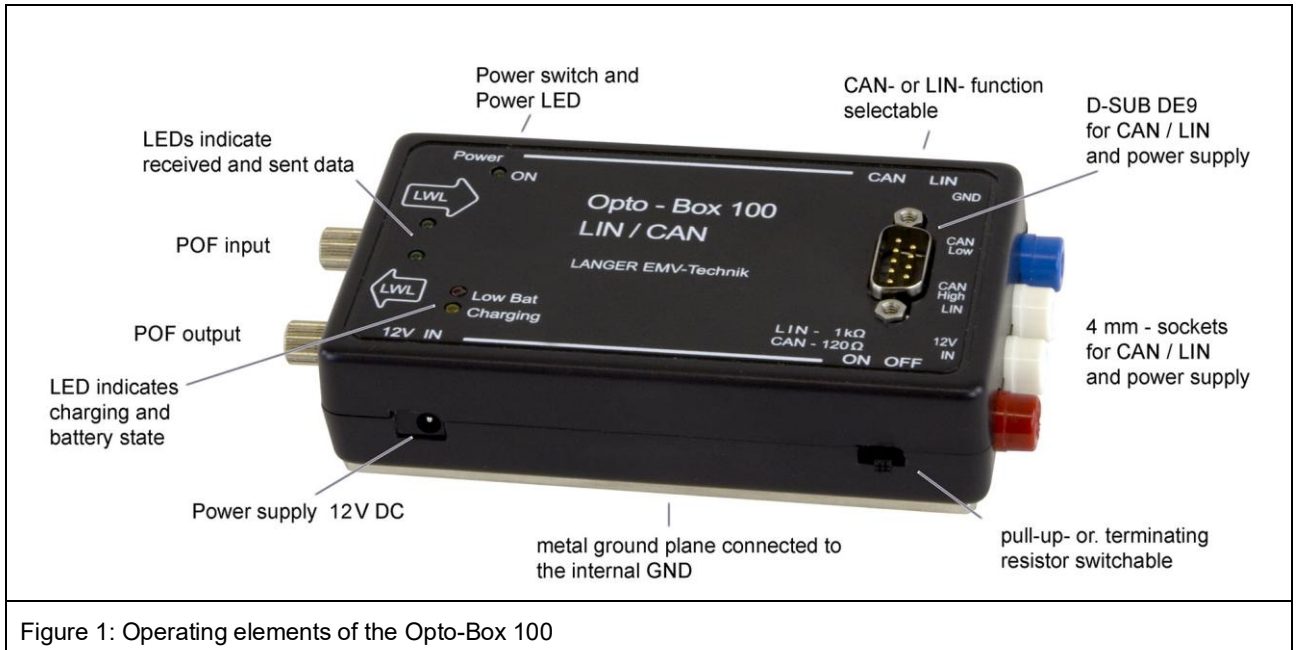

8.2. GND Connection

The Opto-Box has a solid metal plate on the bottom side, which is galvanically connected several times to the internal GND.

If the Opto-Box 100 is used in the context of interference immunity tests, it should be operated isolated from the rest of the set-up to achieve the highest possible interference immunity of the signal transmission. Many standards require this set-up anyway. For this purpose, the Opto-Box must be placed isolated - if possible, with a distance of a few centimeters - above the frequently conductive substrate of the measurement set-up.

For measurements during development, however, it may be useful to connect the DUT and the Opto-Box to a conductive substrate to reduce RF coupling in or out. In this case, it is sufficient to simply place the Opto-Box on the conductive substrate (Figure 2).

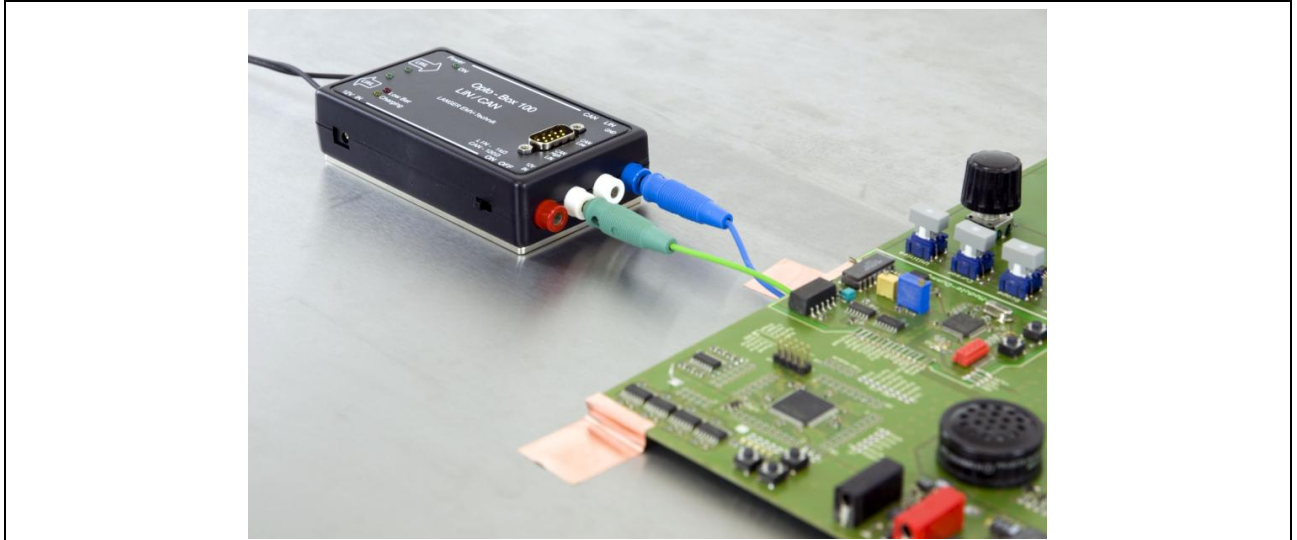

Figure 2: Opto-Box 100 in LIN mode, measurement set-up for measurement during development

8.3. Voltage Supply

There are 4 possibilities to supply the Opto-Box 100 with voltage. In detail these are:

- a) The DC8 socket marked 12V IN at the lower left edge of the device.
The supplied external plug-in power supply can be connected here. This operating mode should be used if the Opto-Box 100 is operated outside the measuring hall/measuring booth. The Opto-Box 100 is supplied via the power supply unit and the internal rechargeable batteries¹ are charged at the same time.
- b) PIN 9 (12V IN) and PIN 6 or PIN 3 (GND) of the D-SUB connector on the top of the device.
- c) Via rechargeable batteries¹.

4 standard AA NiMh rechargeable batteries¹ can be inserted into the Opto-Box 100 to power the Opto-Box, provided that no other voltage is applied. The state of charge is monitored. If the voltage drops below 4.7 V, the red LED "Low Bat" lights up.

If the Opto-Box 100 is supplied via a plug-in power supply unit at the DC8 socket, the batteries¹ are charged independently of the operating state of the Opto-Box. The yellow "Charging" LED lights up. When the charging end voltage is reached, charging is interrupted and the "Charging" LED is switched off. The rechargeable batteries¹ can remain in the device.

Note: The rechargeable batteries¹ are only charged during operation via plug-in power supply, but not during operation at 12 V via D-SUB plug or via laboratory plug.

The set charging current corresponds to approximately three times the maximum operating current in battery mode. When using two Opto-Boxes in pairs inside and outside the measuring hall/measuring booth, it is thus possible to exchange the Opto-Boxes at any time if one Opto-Box is discharged and the second Opto-Box is permanently operated via plug-in power supply.

To replace rechargeable batteries¹, the Opto-Box must be switched off and the two screws in the middle of the bottom side of the device must be unscrewed (Figure 3). After removing the upper part of the housing, the batteries¹ are accessible.

¹ Not included in the scope of delivery.

Only 4 NiMh batteries¹ (no fire risk) of the type AA may be used in the Opto-Box. It is possible to operate the Opto-Box 100 without rechargeable batteries. However, when supplied via the DC8 socket, the "Low Bat" LED flashes during operation, indicating that no battery can be charged.

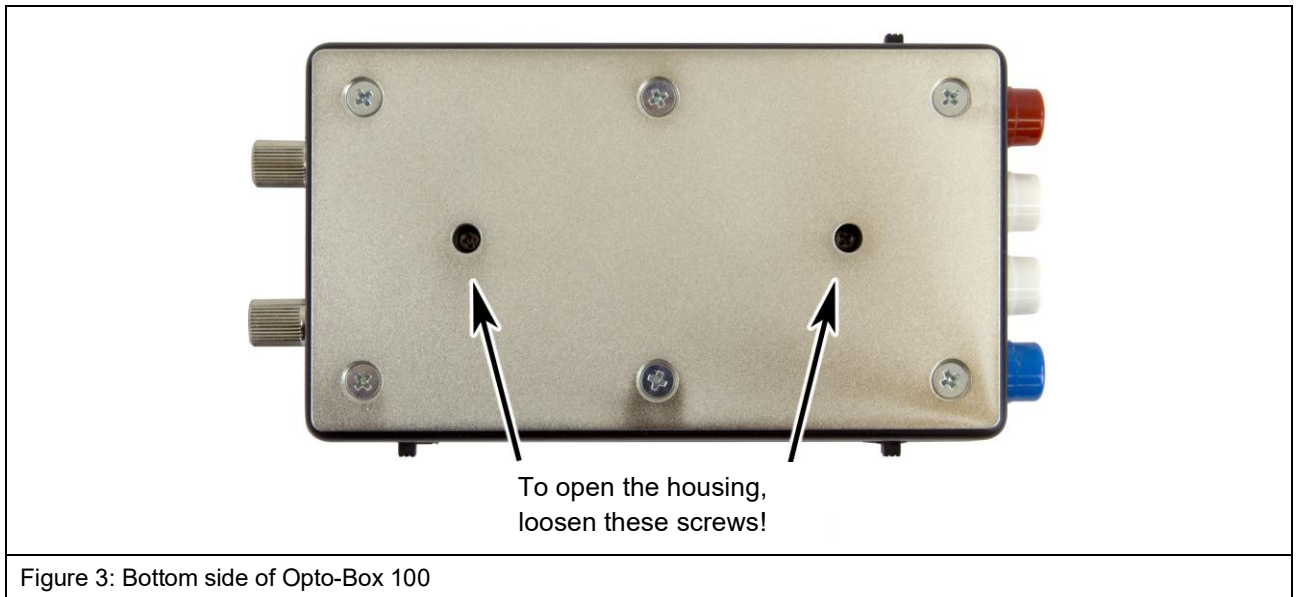

8.4. Signal Transmission – Electrical Connection

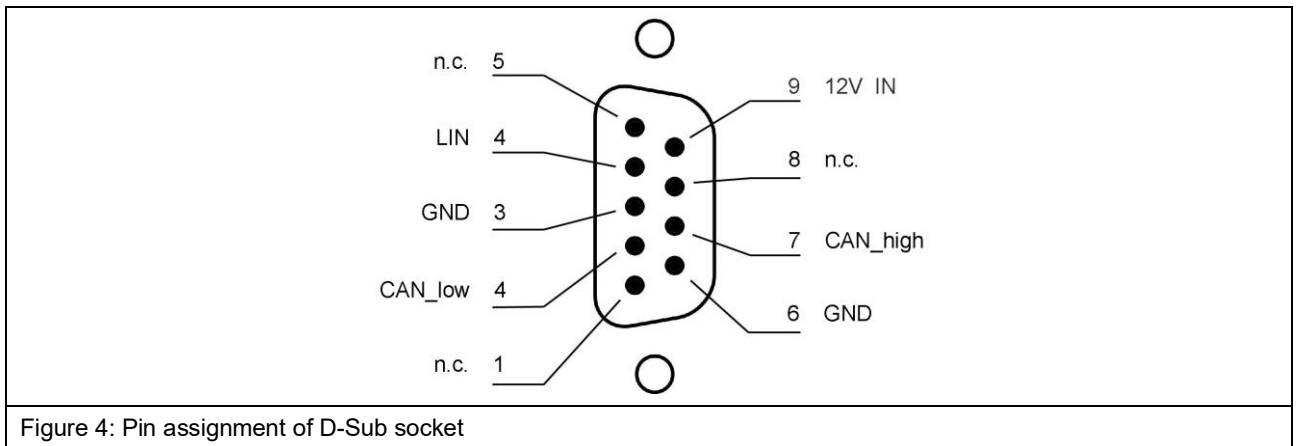

The LIN/CAN switch must first be used to select the operating mode.

In CAN mode, at least both CAN pins must be connected to the CAN signal of the DUT. If required, an internal 120 Ohm terminating resistor (in CAN mode) can be connected via the "LIN / CAN ON OFF" switch.

In LIN mode, at least the signal line and the ground are connected. If required, an internal 1 kOhm pull-up resistor (LIN operation) can be connected for the "Master" operating mode via the "LIN / CAN – ON OFF" switch. If the Opto-Box 100 is operated via laboratory plug or D sub-connector at approx. 12 V, the resistor connects the signal to this voltage. In battery operation, a 12 V voltage is generated internally, and the LIN signal is connected to it via the resistor.

¹ Not included in the scope of delivery.

8.5. Signal Transmission – Optical Connection

The double optical fiber is plugged into the optical fiber input and the optical fiber output (Figure 1) and fixed with both knurled nuts. The ends of the two individual optical fibers are cut to different lengths and can thus be correctly assigned:

The slightly longer optical fiber is always connected to the optical input, the slightly shorter one to the optical output (see marking on the Opto-Box 100, long and short arrow).

The maximum length of the optical fiber is 20 m. In practice, however, in CAN operation at a transmission rate of 1 Mbit/s, the delay of the optical receivers results in a reduction of the permissible length to 6-10 m (depending on the edge steepness of the signal and the reaction time of the other connected CAN nodes), since otherwise the acknowledge bit is no longer recognized in time by the transmitter.

If the Opto-Box 100 is only used for "listening" to an existing CAN connection between other nodes, this restriction does not exist.

9. Use of Opto-Box 100

9.1. Measurements according to Standards

To decouple LIN or CAN lines during EMC measurements in a measuring booth or an anechoic chamber, two Opto-Boxes can be connected to each other via optical fibers (Fig. 5). The Opto-Box located outside the hall should be permanently supplied via plug-in power supply. Its batteries¹ are thus also charged during operation. If the batteries¹ of the Opto-Box inside the hall are discharged, the Opto-Boxes can be exchanged at any time, and the measurements can be continued.



Figure 5: Two Opto-Boxes for data transmission connected via fiber optics

To improve the EMC properties, we recommend (as specified in various standards anyway) that the opto-box used inside the hall on the DUT be operated in isolation with a distance of a few centimeters from any metallic base surface of the test set-up (Figure 6).



Figure 6: Opto-Box 100 operated isolated

¹ Not included in the scope of delivery.

9.2. Measurements during Development

During development, it can be helpful to perform disturbance emission or disturbance immunity measurements without LIN or CAN lines connected - for example, to determine whether the functional error during coupling directly affects a CAN signal and a subsequent error occurs, or whether coupling into another structure of the DUT causes the error.

If a signal connection is required to control or monitor the DUT in this case, it is necessary to use a CAN 100 or LIN 100 sensor in conjunction with an Opto-Box (Figure 7). If the sensor is used as described in section 10.3, it is possible to communicate with the DUT without any metallic signal line.



Figure 7: One sensor with one Opto-Box for data transmission without LIN/CAN bus cable

To prevent the propagation of interference pulses via the signal lines when performing immunity tests during development, e.g. with ESD or burst, the Opto-Box can be used for galvanic isolation. If the test set-up is implemented with the aid of a metal surface, the Opto-Box can also be connected to the metal surface as in Figure 8.

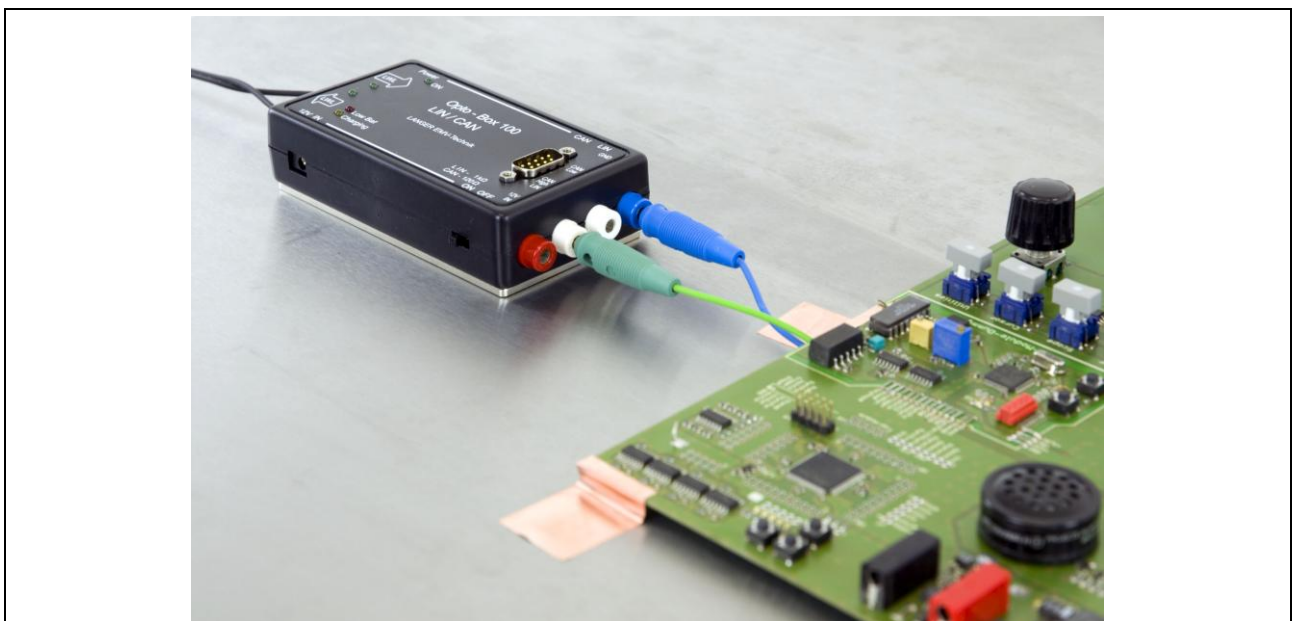
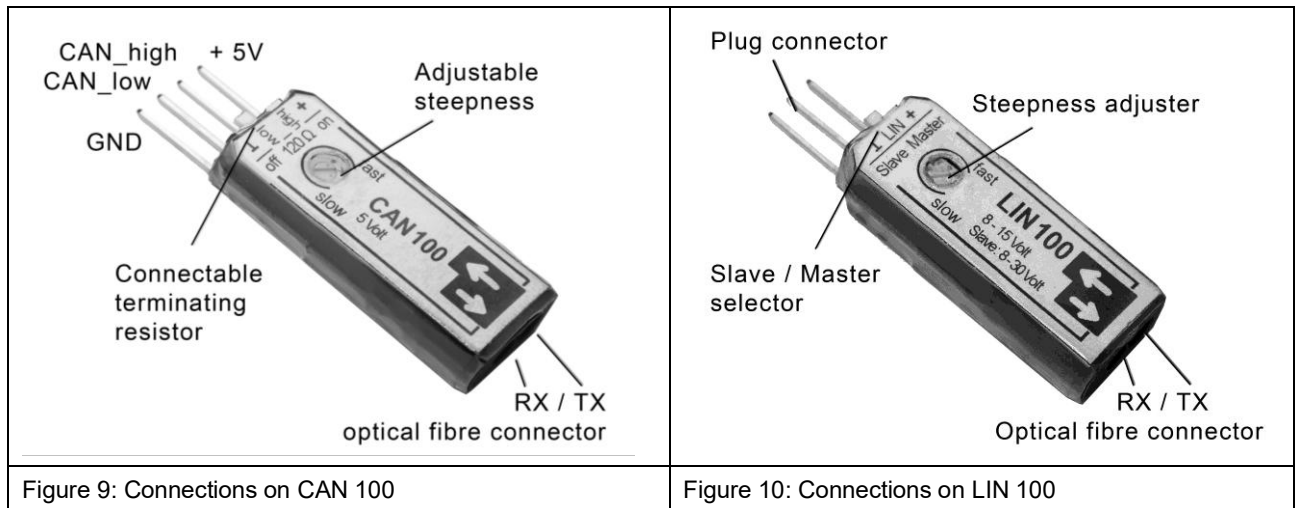

Figure 8: Opto-Box connected with metal surface

10. CAN 100 / LIN 100 Sensors

10.1. Mechanical Design

The CAN 100 and LIN 100 sensors are pluggable and have a GND, a supply, and a CAN or LIN connection. The optical connection is designed for a 2.2 mm double plastic optical fiber (pluggable) (Figure 9 and Figure 10).



10.2. Optical Connection

The double fiber optic cable is simply plugged into the CAN 100 / LIN 100.

At both ends, the two individual optical fibers are cut to different lengths and thus assigned to the correct opening on the CAN 100: The slightly longer optical fiber is always connected to the optical input (long arrow), the slightly shorter one to the optical output (short arrow) (Figure 11). The longer optical waveguide must also be pushed further into the CAN 100 (up to the stop), so that when correctly connected, the double optical waveguide is just connected to the CAN 100 / LIN 100.

The maximum length of the optical fiber is 20 m.

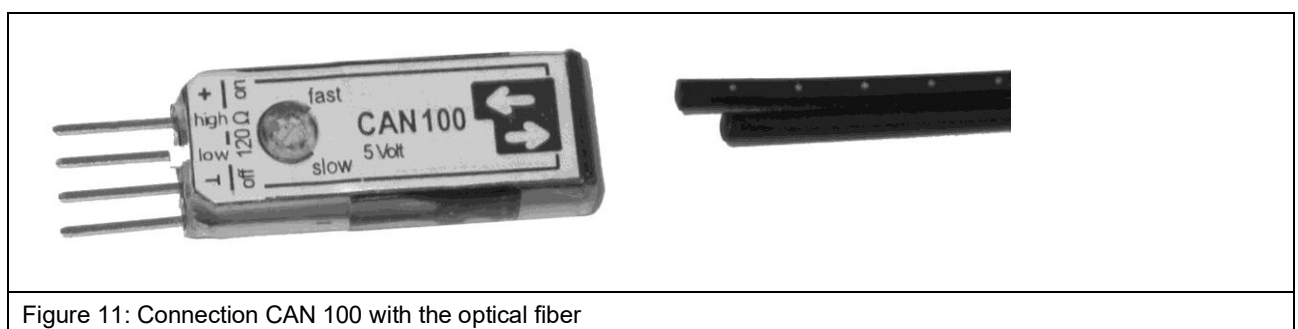

Figure 11: Connection CAN 100 with the optical fiber

Attention with CAN 100 and 1 MHz transmission rate:

At a transmission rate of 1 Mbit/s, however, the delay of the optical receivers limits the possible length (depending on the edge steepness and response time of the other connected CAN nodes) to less than 20 m.

If the CAN 100 is only used to "listen in" on an existing CAN connection between other nodes, there is no such limitation.

10.3. Electrical Connection

The CAN 100 is supplied with GND and +5 V supply voltage from the electronics module. If the supply voltage rises above approx. 7 V, the CAN 100 switches off to avoid overheating. Both CAN pins are connected to the CAN signal of the electronics. If required, an internal 120 Ohm terminating resistor can be connected via the switch on the CAN 100.

The edge steepness of the signals output by the CAN 100 can be changed with a screwdriver. Depending on the transmission rate, a minimum edge steepness is required; at a transmission rate of 1 Mbit/s, the setting control must be set to "fast" (delivery state).

The LIN 100 is supplied with GND and supply voltage from the electronics module, the LIN pin is connected to the LIN signal of the electronics. Via the switch at the LIN 100 an internal 1 kOhm pull-up resistor can be connected if required (for operation as master).

With a screwdriver the edge steepness of the signals output by the LIN 100 can be changed. Depending on the transmission rate, a minimum edge steepness is required, at 20 kHz transmission rate the setting control must be set to "fast" (delivery state).

Note: To measure error-free under RF irradiation, burst or ESD, the CAN 100 must be connected to the DUT for a very short time.

Probe tips of the usual type are too large. For a correspondingly small-scale set-up, it is recommended to solder the CAN 100 directly into the module via an adapter socket (included in the scope of delivery). For this purpose, the socket is glued onto the PCB or an IC of the DUT (with superglue or double-sided adhesive tape) and connected to the DUT with CuL wire according to the pin assignment (Fig. 12). The connection with the wire should be as short as possible.



Hint:

The closer the CAN 100 / LIN 100 is arranged with its housing to the GND system of the DUT and the shorter the GND connection to the module, the greater the interference immunity of the set-up.

Figure 12: CAN 100 optimally used

11. Warranty

Langer EMV-Technik GmbH will remedy any fault due to defective material or defective manufacture during the statutory warranty period either by repair or by delivery of spare parts.

This warranty is only granted on condition that:

The information and instructions in the user manual have been observed.

The warranty will be forfeited if:

An unauthorized repair is performed on the product.

The product is modified.

The product is not used for its intended purpose.

The product is opened in a way that is not described in this user manual.

12. Customer Service

Please contact us if you have any questions, comments or suggestions.

You can contact us:

Monday – Friday

8:00 Uhr bis 15 Uhr (CET)

Contact us at:

Address: Langer EMV-Technik GmbH
Nöthnitzer Hang 31
01728 Bannewitz
Germany

Internet: <https://www.langer-emv.com/>

E-mail: sales@langer-emv.de

Phone: +49 (0) 351-430093-0

Fax: +49 (0) 351-430093-22

Calibration

We recommend having the product calibrated every two years by the manufacturer Langer EMV-Technik GmbH or by a certified distributor.